



# NEW BIG

2



# FUN Workbook

Mario Herrera  
Barbara Hojel

 Pearson



موسسه زبان دهخدا  
dekhodaedu.com



**NEW**  
**BIG**  
**FUN**  
**WORKBOOK**



**Mario Herrera**  
**Barbara Hojel**



**New Big Fun  
Workbook 2 with Audio CD  
Pearson Education Limited**

KAO Two, KAO Park, Hockham Way, Harlow, CM17 9SR, England and Associated Companies throughout the world.  
www.English.com  
© Pearson Education Limited 2018

Authorized Adaptation from the U.S. edition, entitled Big Fun, 1st Edition, by Mario Herrera and Barbara Hojel, published by Pearson Education Inc, © 2014 by Pearson Education, Inc.  
The right of Mario Herrera and Barbara Hojel to be identified as authors of this Work has been asserted by them in accordance with the Copyright, Designs and Patents Act 1988.  
All rights reserved; no part of this publication may be reproduced, stored in a retrieval system, or transmitted in any form or by any means, electronic, mechanical, photocopying, recording, or otherwise without the prior written permission of the Publishers

First published 2018

ISBN: 978-1-292-26574-2

Set in Gill Sans Infant Std, Avenir LT Pro, ITC Avant Garde Gothic Std, Banco ITC Font

Printed in China (SWTC/01)

**Text composition:** Isabel Arnaud

**Illustration credits:** A Corazón Abierto, Francisco Morales, Luis Alberto Montiel Villegas, Javier Montiel

**PEARSON ELT ON THE WEB**

**PearsonELT.com** offers a wide range of classroom resources and professional development materials. Access course-specific websites, product information, and Pearson offices around the world.

Visit us at [www.pearsonELT.com](http://www.pearsonELT.com).

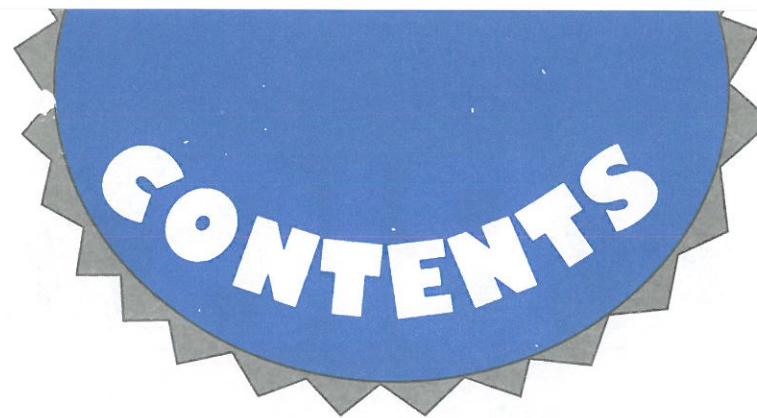

# CONTENTS

<b>1</b> My School .....	1	<b>6</b> My Clothes .....	51
<b>2</b> My Senses .....	11	<b>7</b> Animals.....	61
<b>3</b> My Family .....	21	<b>8</b> My World .....	71
<b>4</b> My Toys .....	31	<b>9</b> Show Time! .....	81
<b>5</b> Food.....	41		



# NEW BIG FUN

## Song

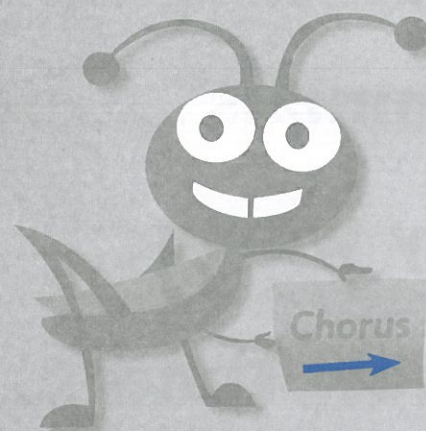
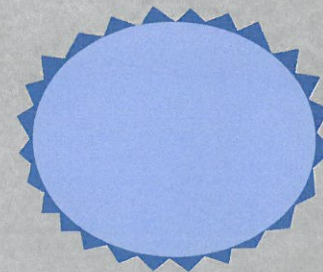

*From the sky to the ground  
And all the way around—  
We can have big fun!  
If there's rain, if there's sun,  
Let's play with everyone.  
We can have big, big fun!*

**Take a walk outside.  
Our world is big and wide.  
There are flowers and trees  
And yellow bumblebees.  
Buzz, buzz, buzz!**

***(Chorus)***

**Join your hands with me.  
Let's see what we can see!  
Then take a closer look.  
We'll learn beyond our book.  
Look, oh, look!**

***(Chorus)***



# MY SCHOOL

Find and circle. 



Trace and color.

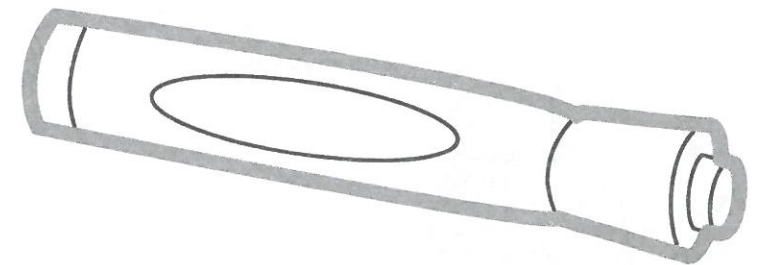
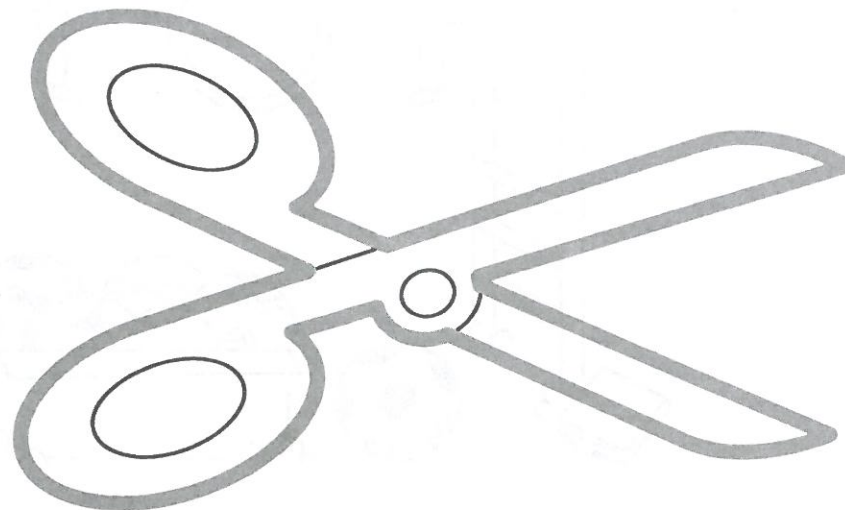
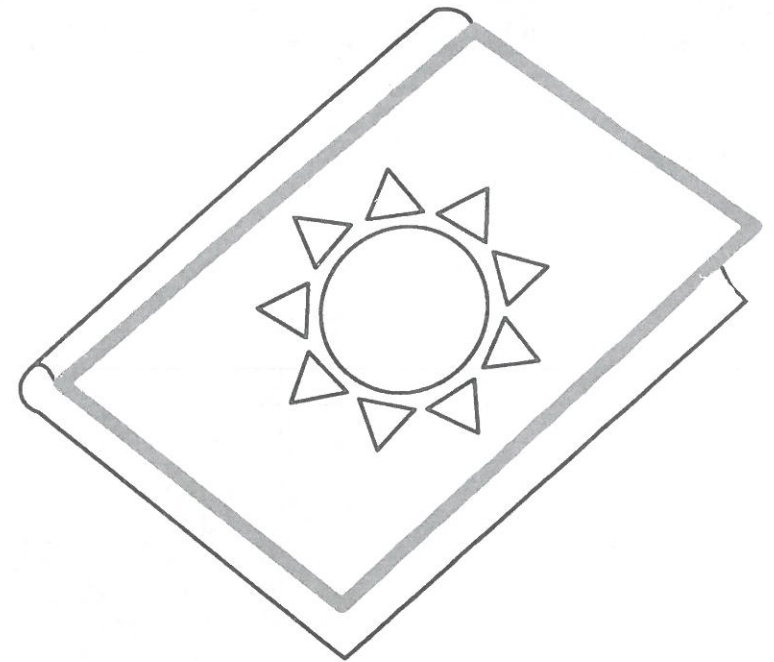
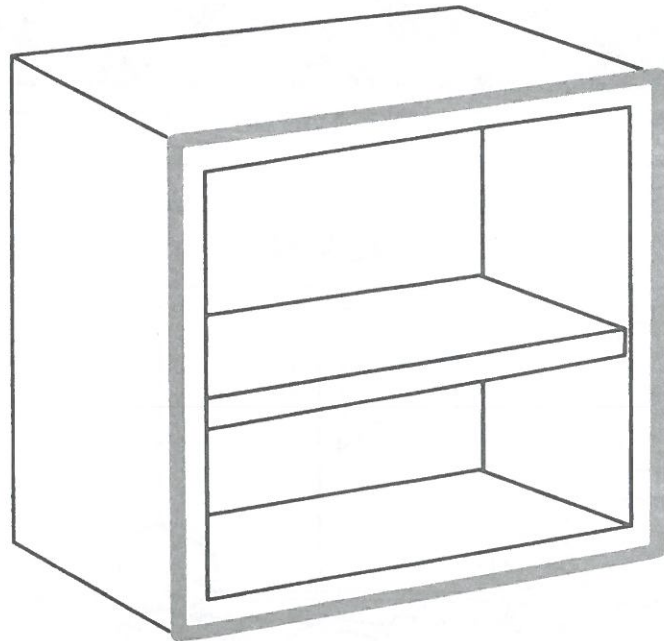

Vocabulary Practice: *shelves, book, scissors, marker*  
Language Practice: *These are (scissors). This is (a book).*

Look and match.

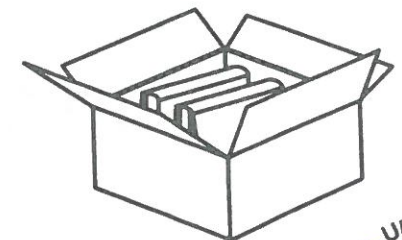
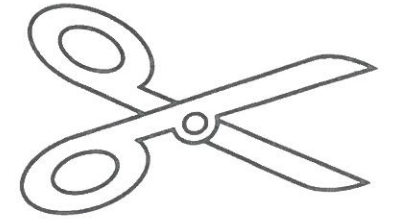
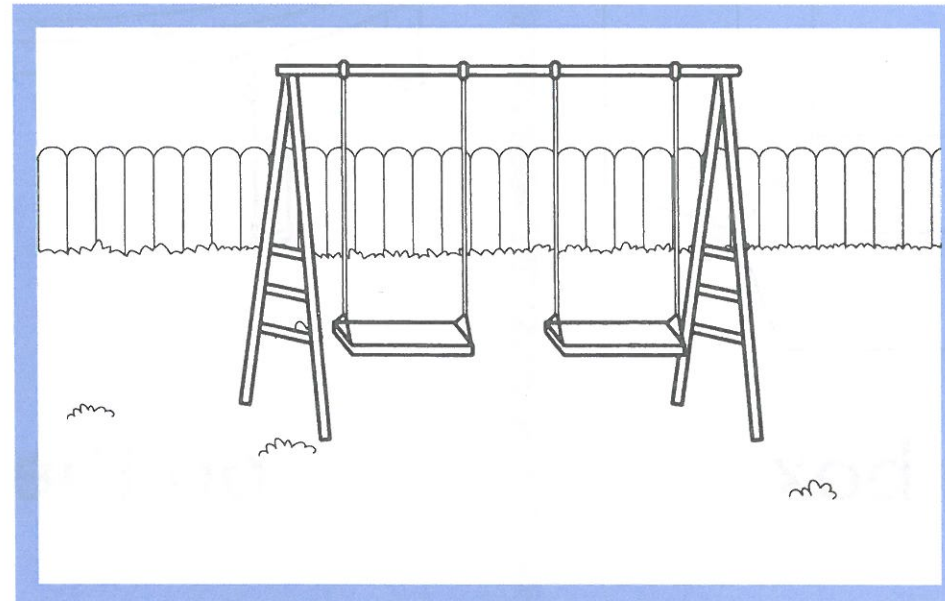
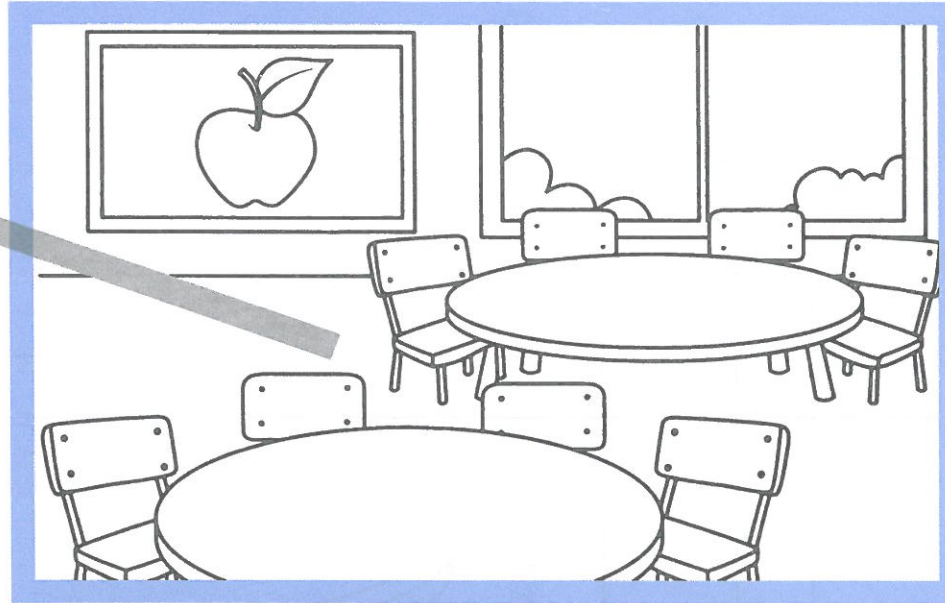
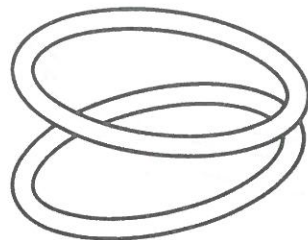
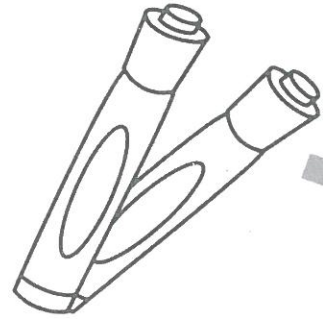

Vocabulary Practice: *inside, outside; markers, hoops, jungle gym, scissors, ball, box, books*



Look and draw a ball in each scene. Color.

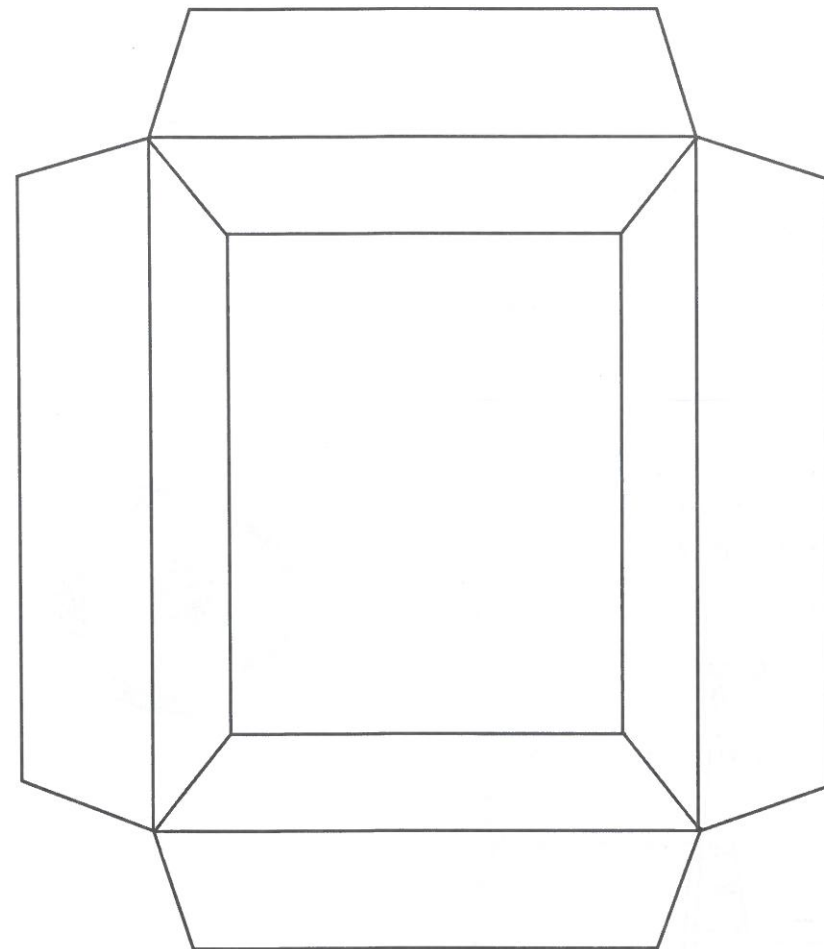

in the box

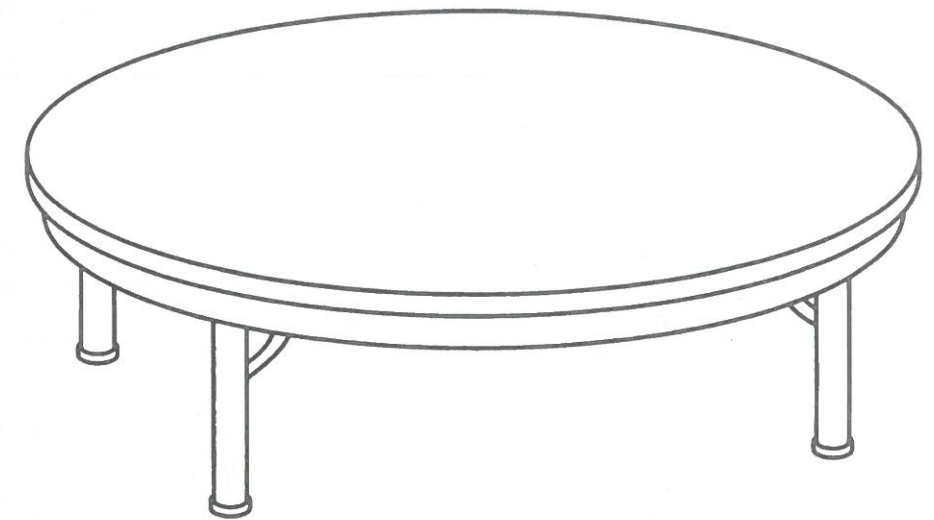

on the table

Count and trace.

1

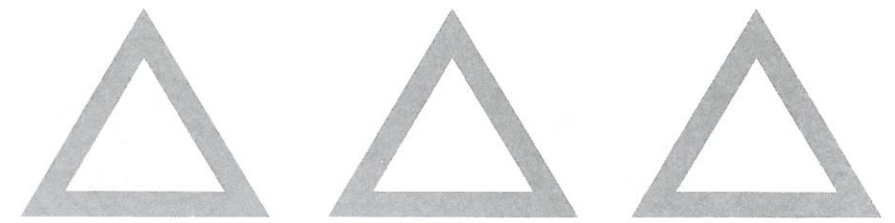
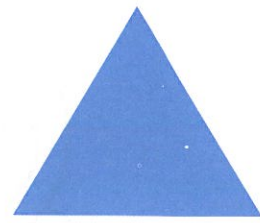

2

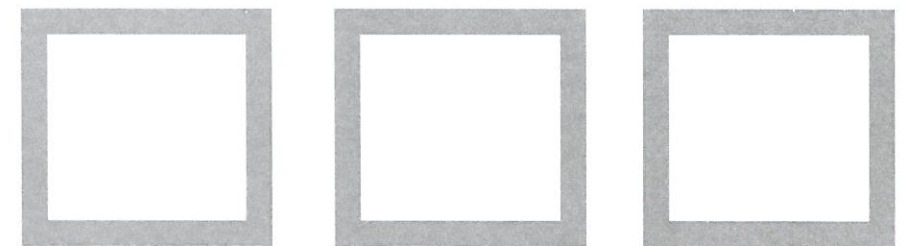
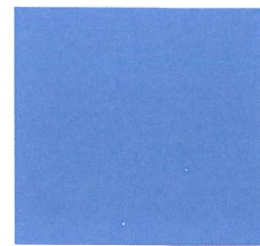

3

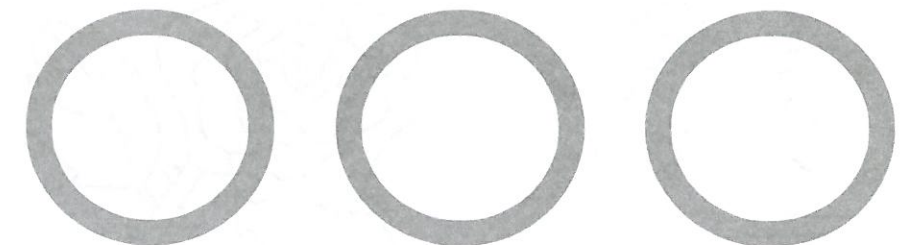
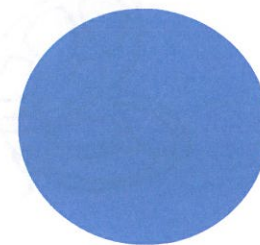

Look and match. Color.

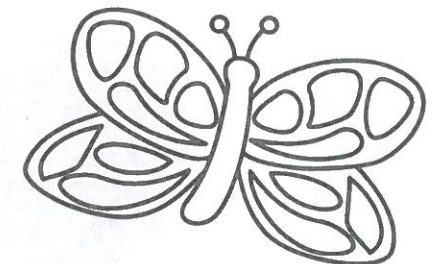
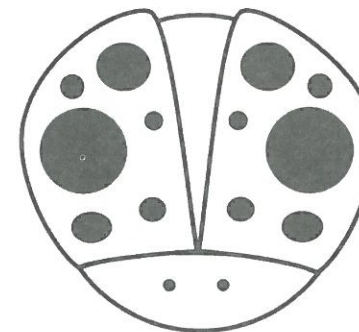
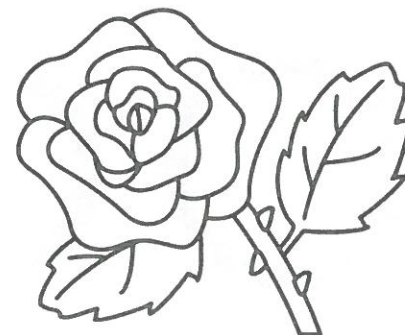
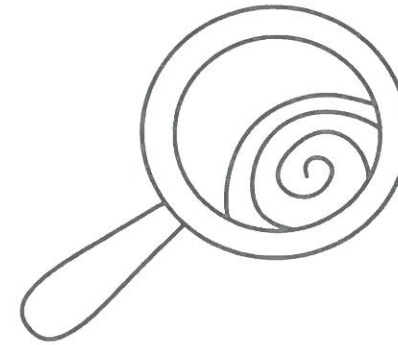
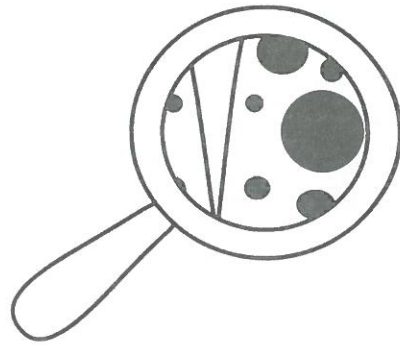



Look and listen. Trace.

# Draw and Color

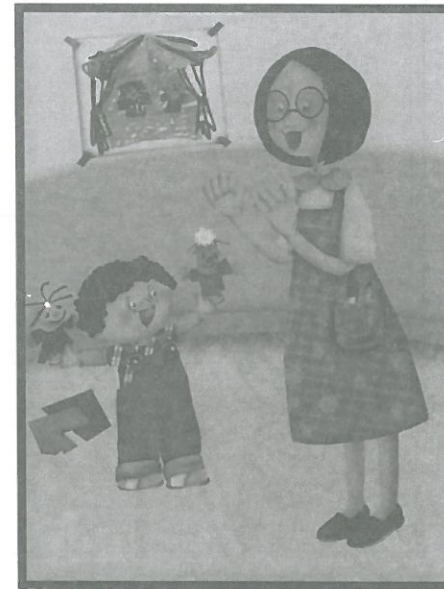

Story Sequence: Draw and Color

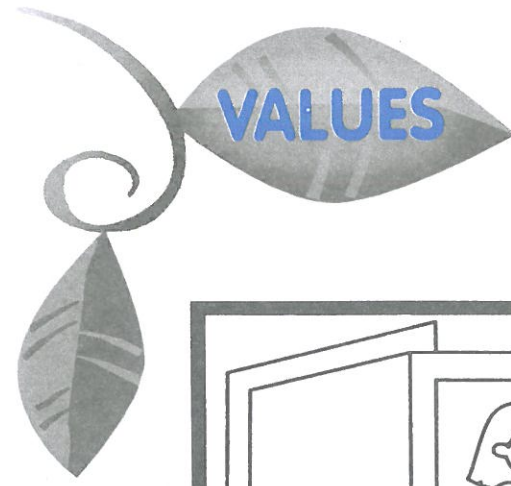

**VALUES**

**Are they listening to the teacher?  
Look and color the correct face.**

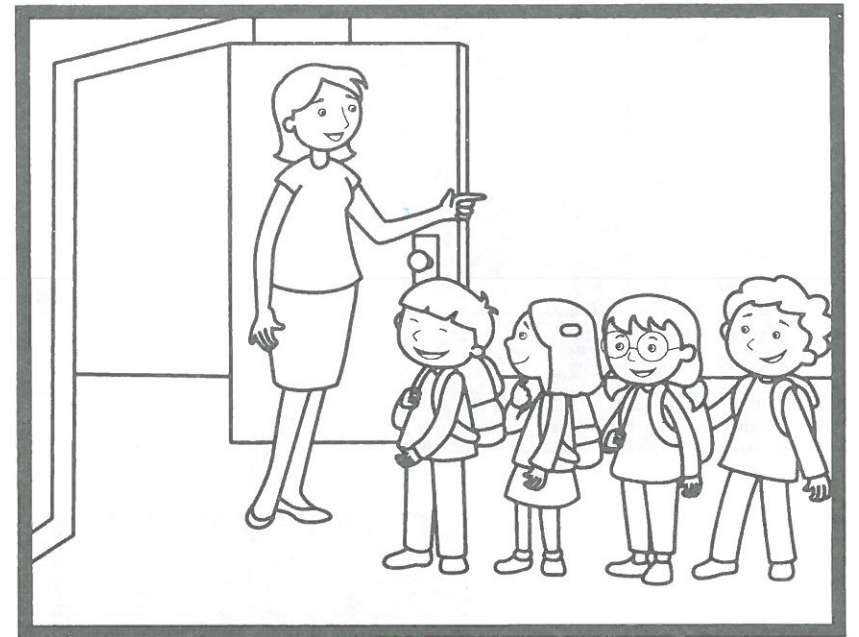
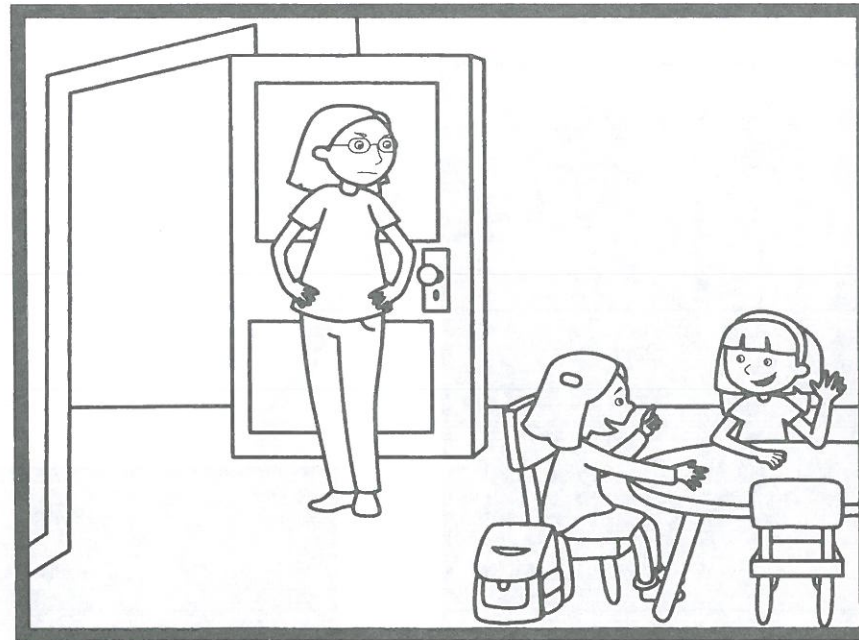



Trace the numbers and follow the trails.

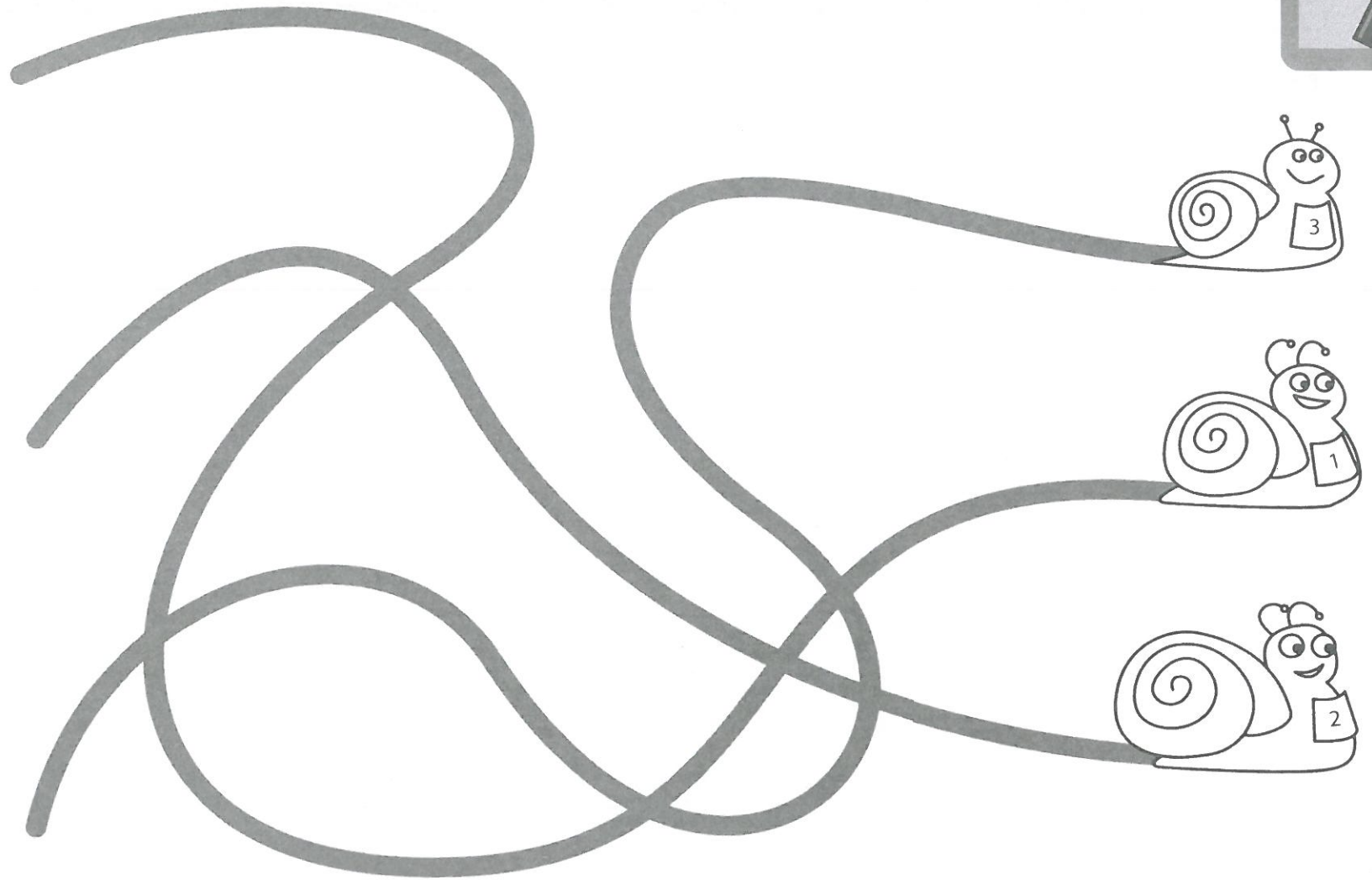



# MY SCHOOL

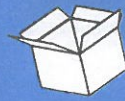

Draw your school.

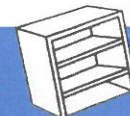
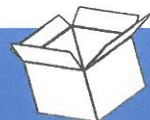
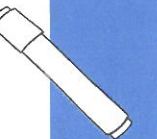
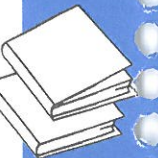
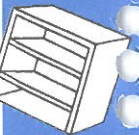
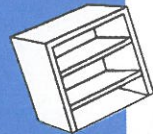

2

# MY SENSES

Find and circle. 



Opener  
FIND IT: banana (taste), bee (hear), ball (touch)



**Draw the missing body parts. Color.**



Circle or cross out.

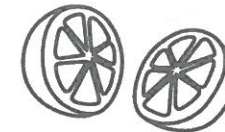
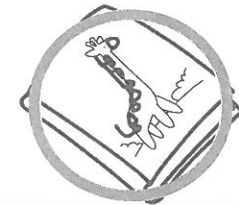
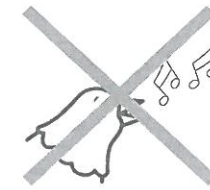

Match and color.

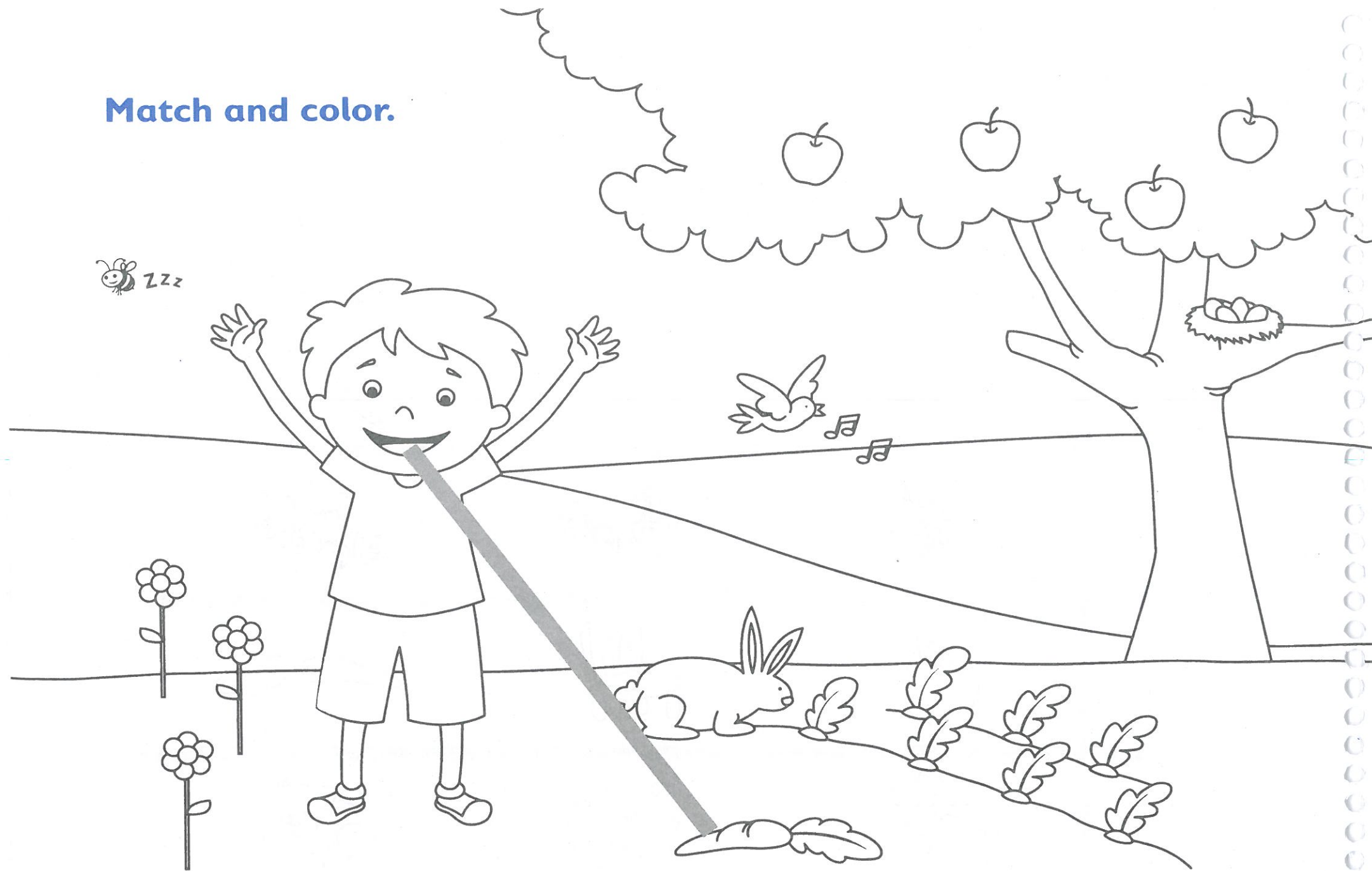

Count and Color.

4

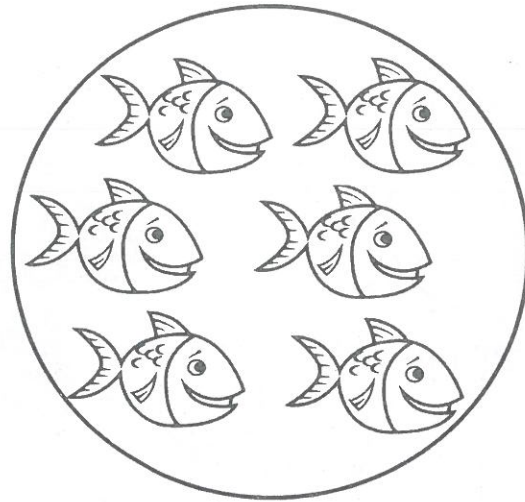

5

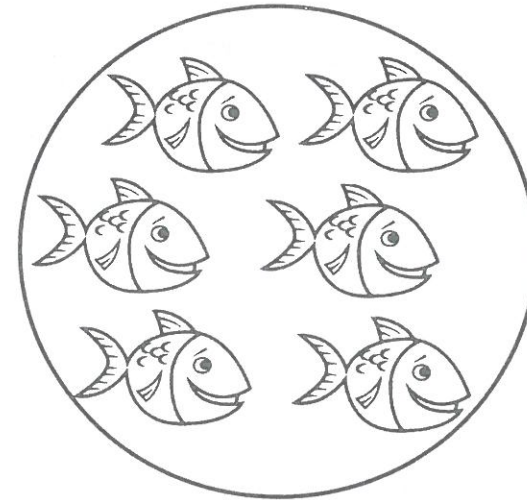

6

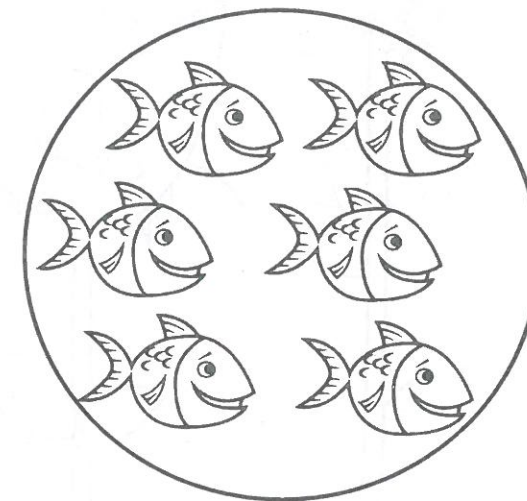

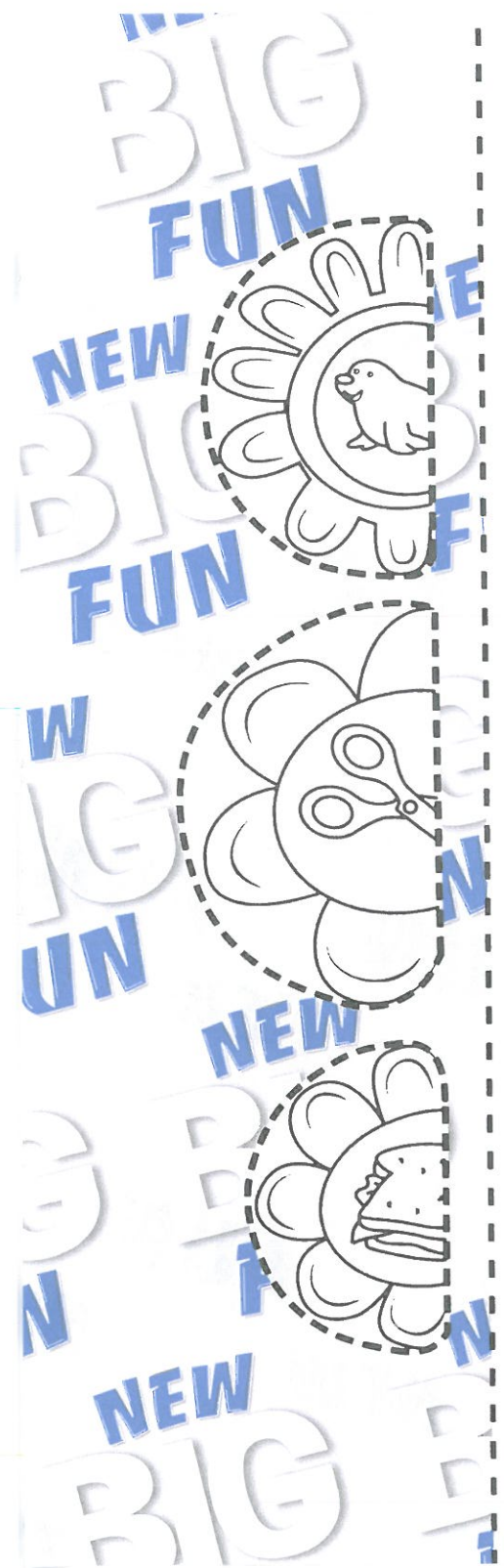

✂ Cut out, match, and paste.

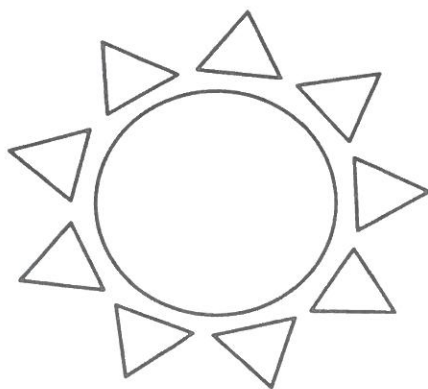



Look and listen. Draw the arrow to the next picture.

## Guessing Game



**VALUES**

**Are they waiting for their turn?  
Look and match.**

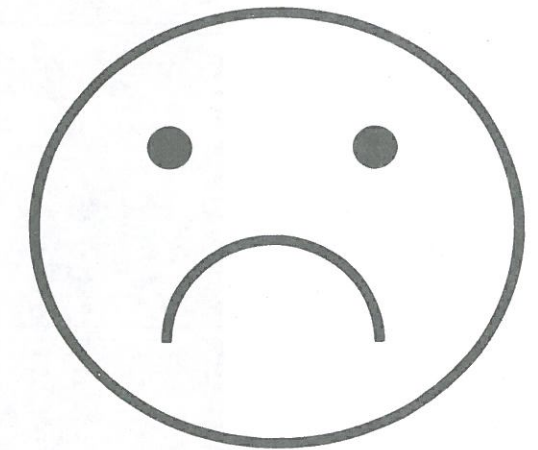
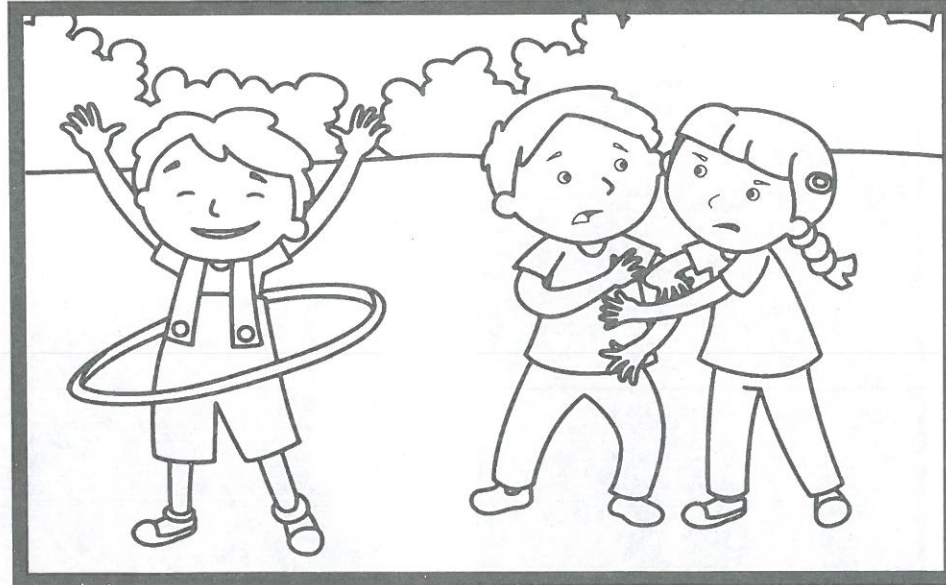

Look and match.

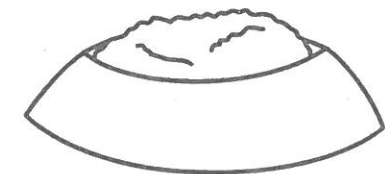
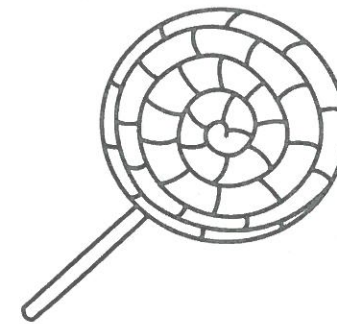
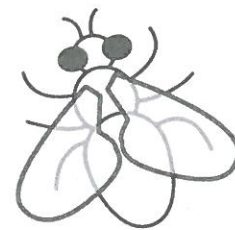
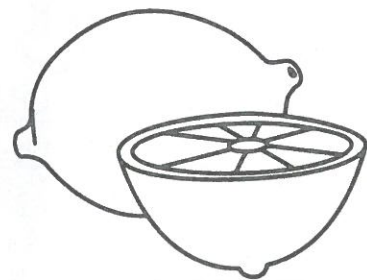
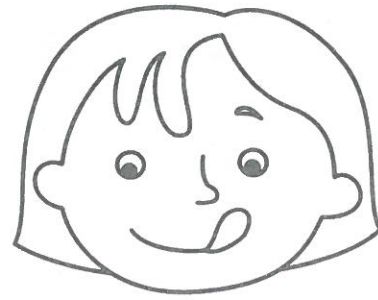
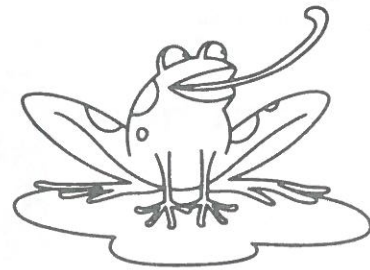



# MY SENSES

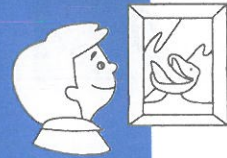

Draw something you can smell and something you can hear

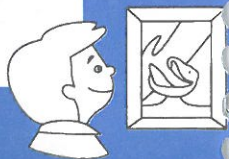
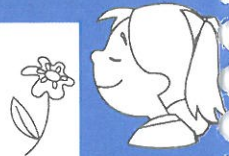

3

# MY FAMILY

Find and circle. 



Trace and draw or paste photos of family members.



Count and color. Write the missing numbers.

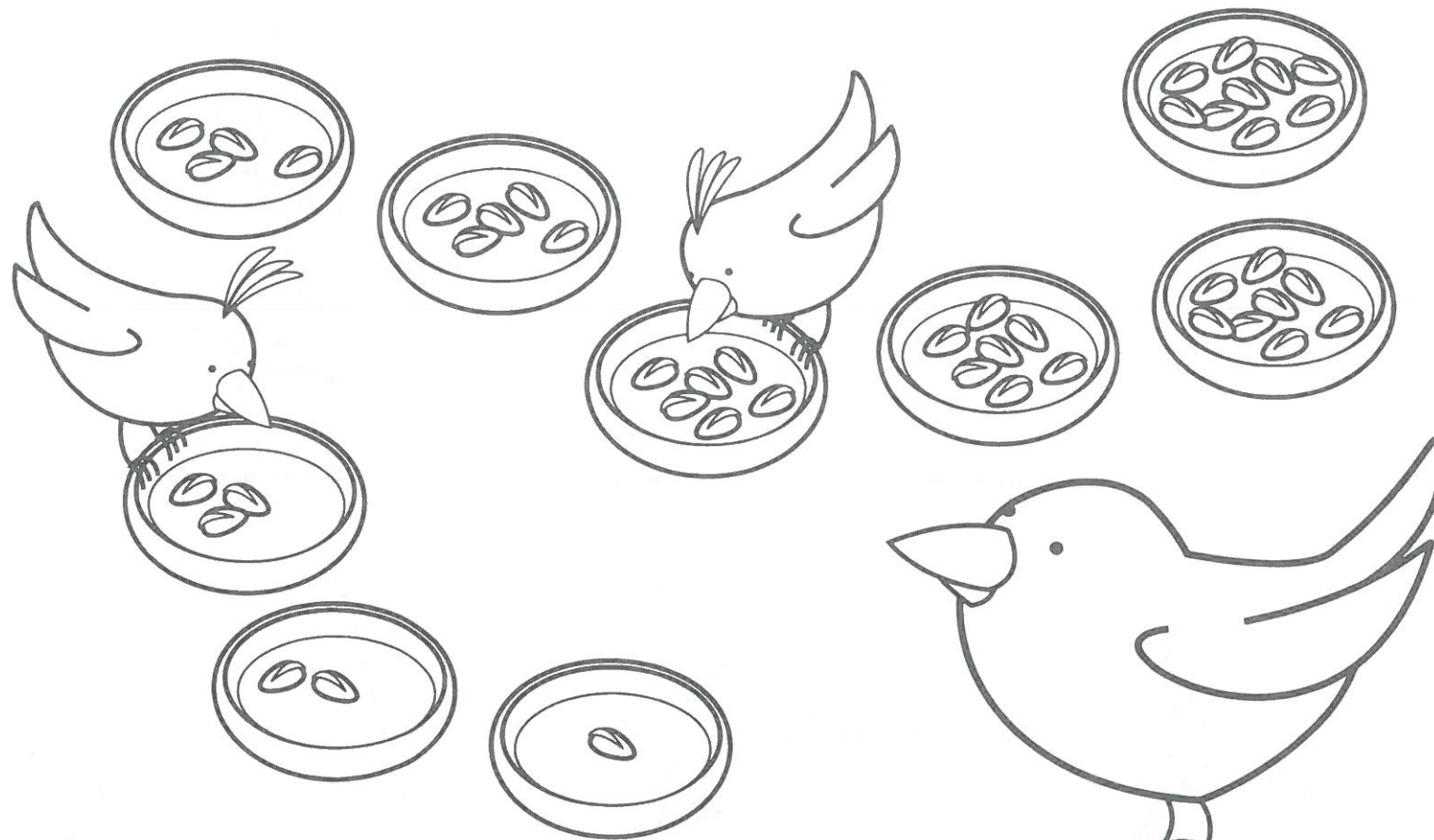

1    \_    3    4    \_    6    7    \_    9



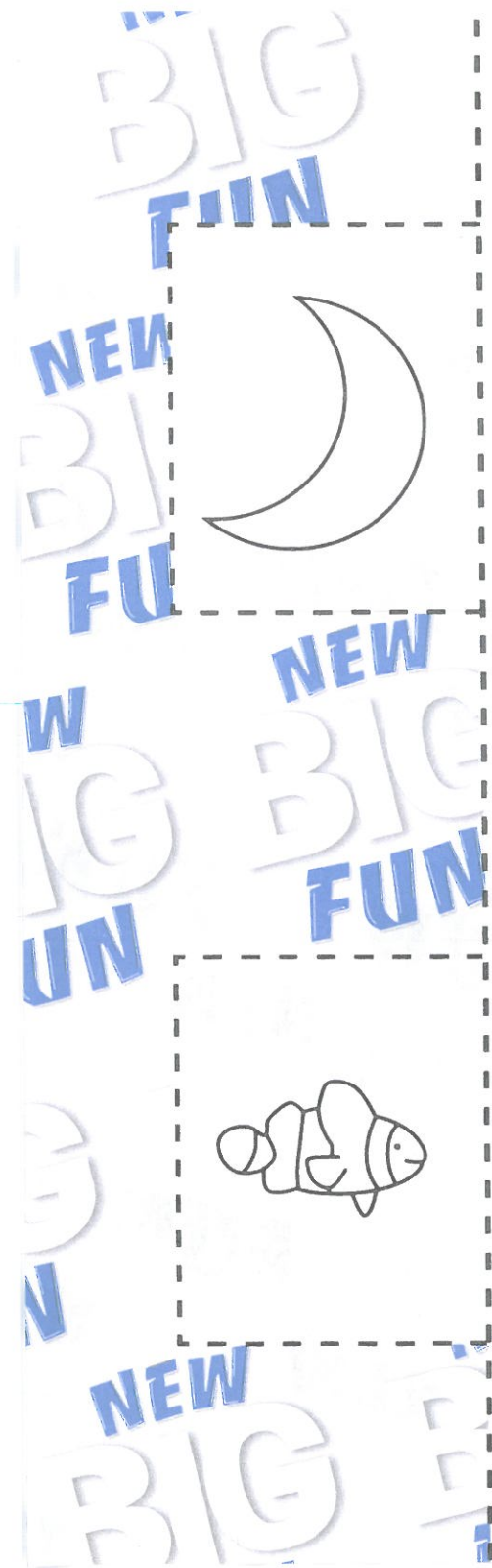

✂ Cut out, match, and paste.

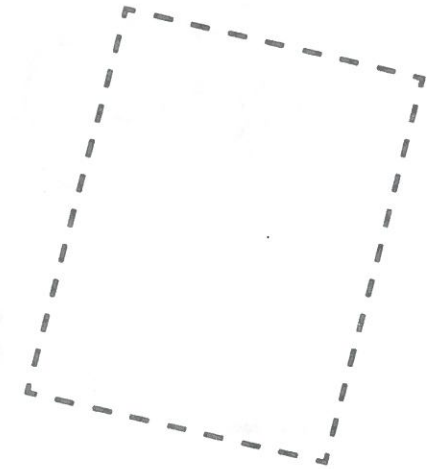
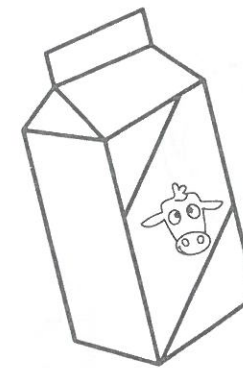
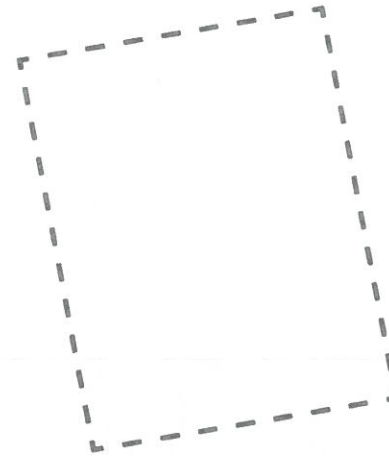



Look and listen. Draw an arrow to the next picture.

# Show and Tell

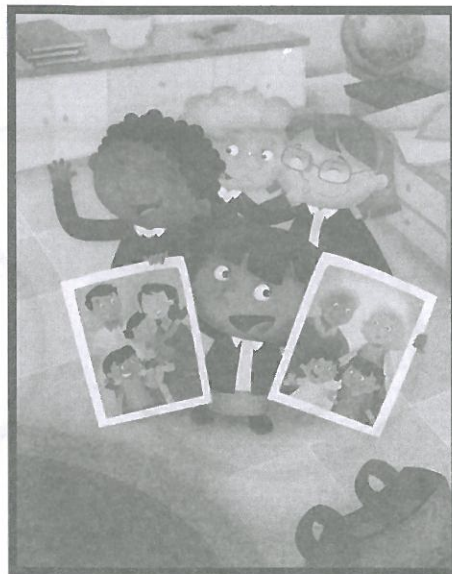
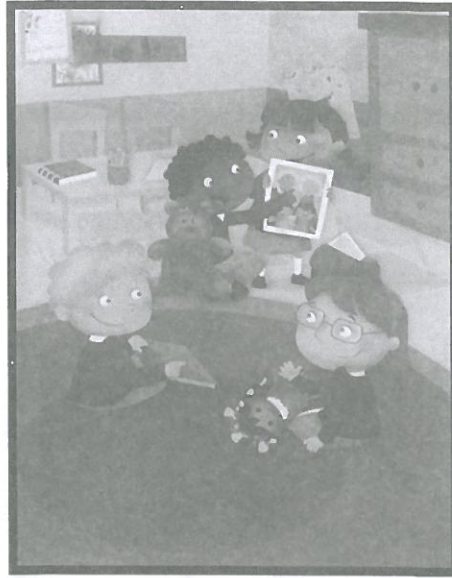

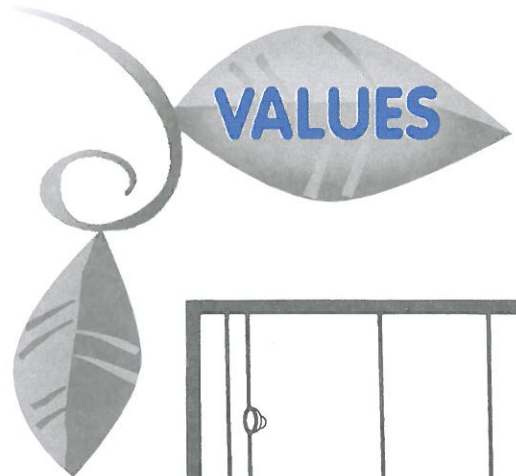

**VALUES**

**Do they appreciate their family members?  
Look and color the correct face.**

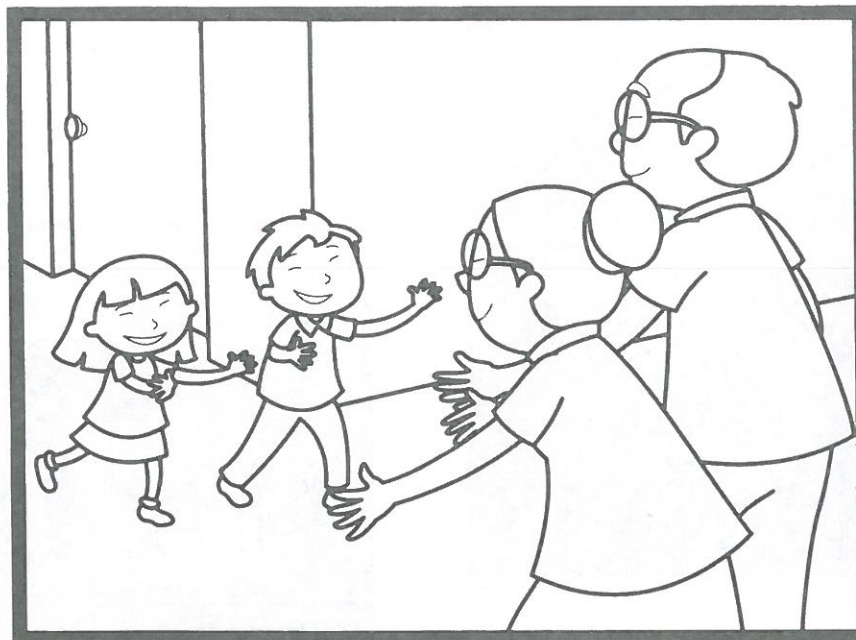



Trace, draw more eggs, and color.





# MY FAMILY

Draw your family.



4

# MY TOYS

Find and circle. 

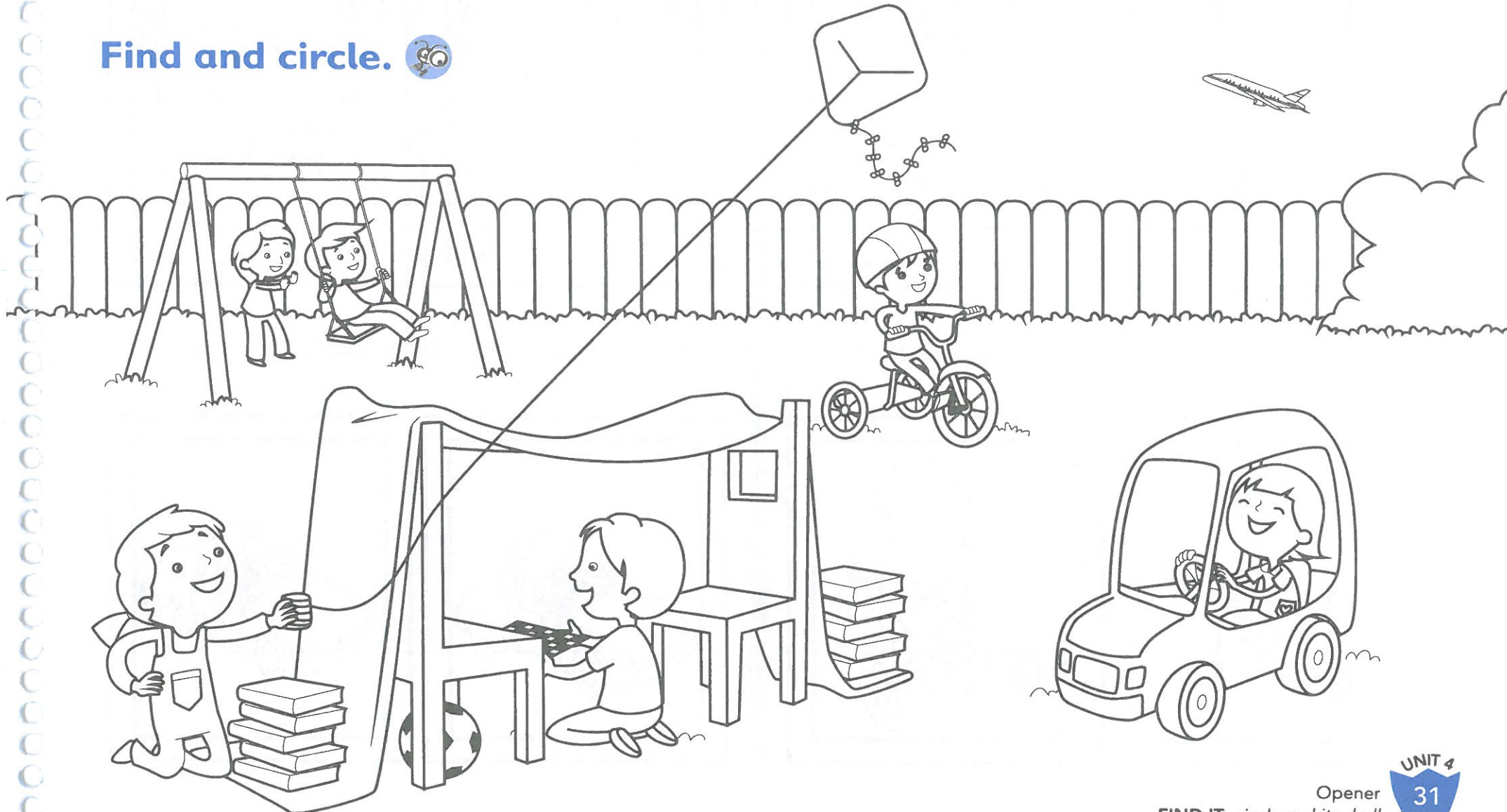

Same or different? Color the frames if the pictures are the same.

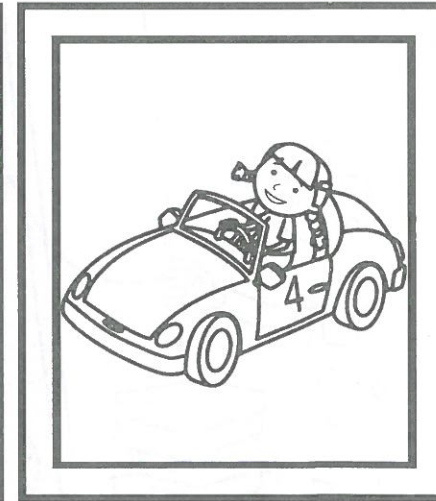
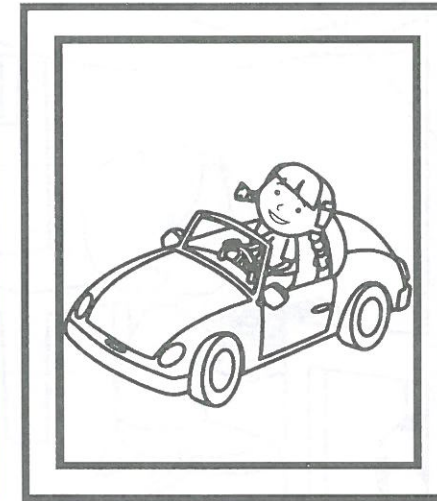
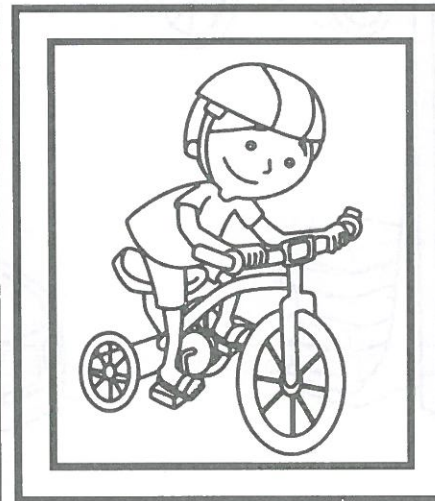

Circle a toy you have in blue. Then circle a toy you want in green.

I have  BLUE

I want  GREEN

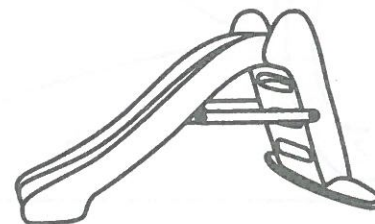
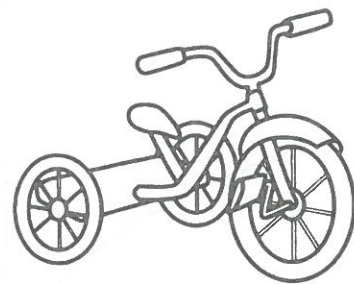
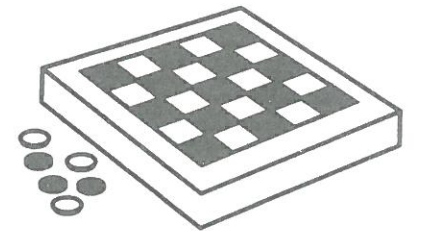
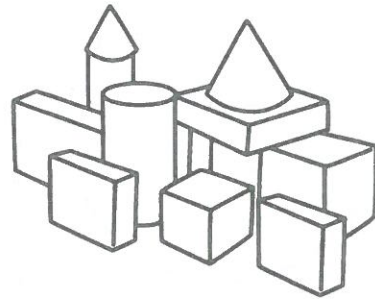

Color the crayons. Then color by number.

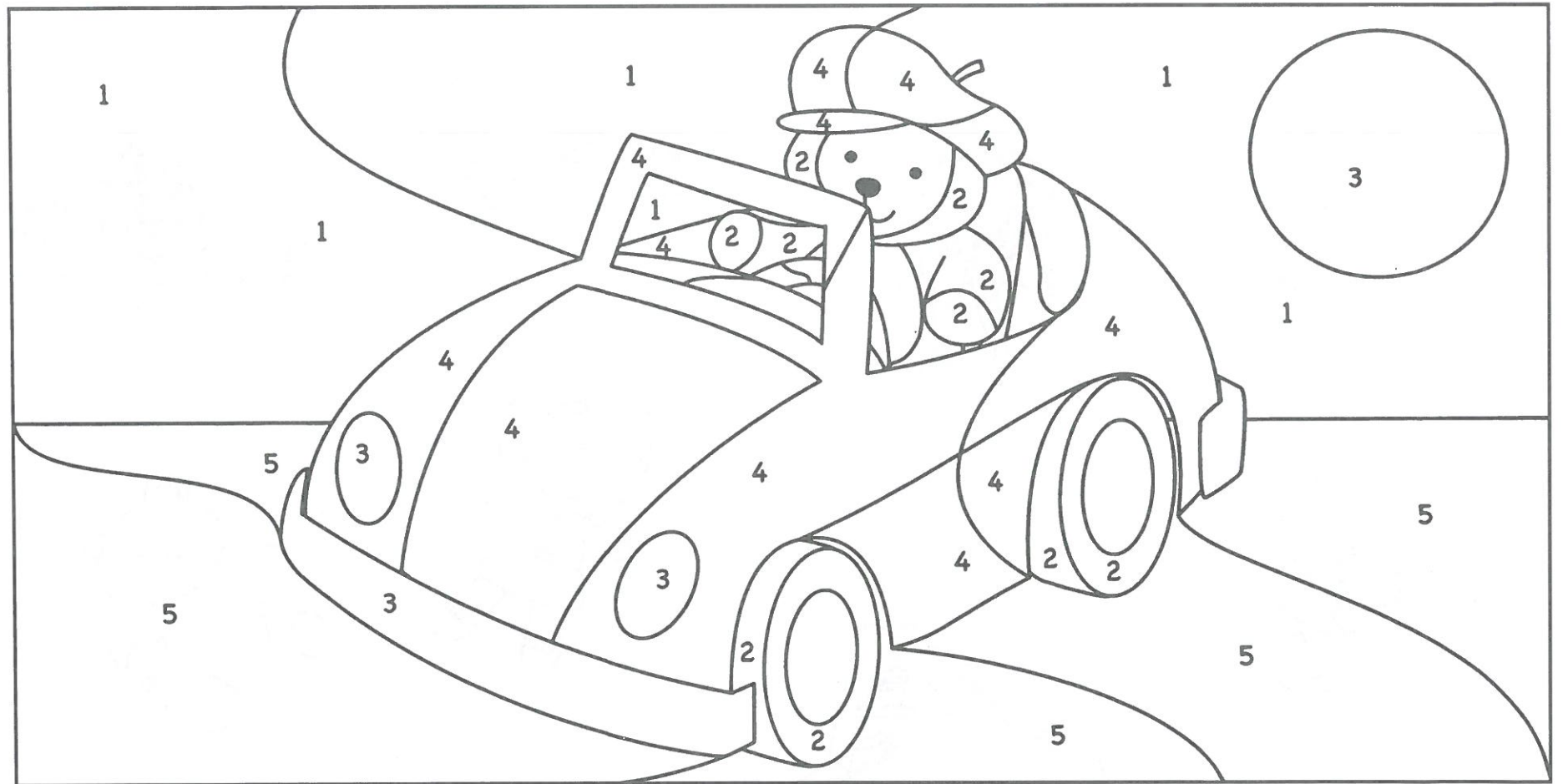
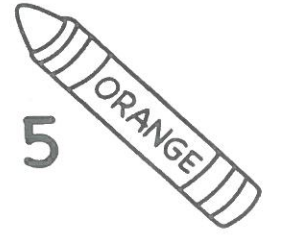
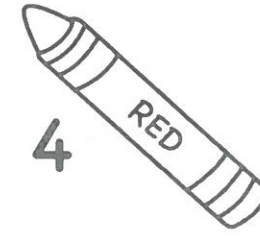
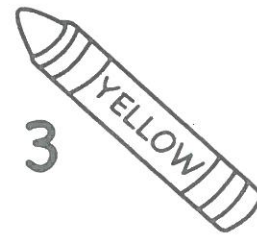
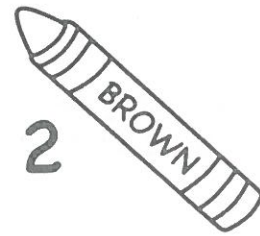
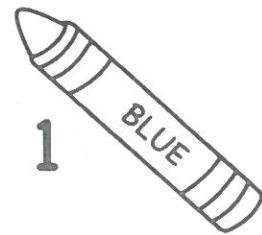

Count, trace, and color.

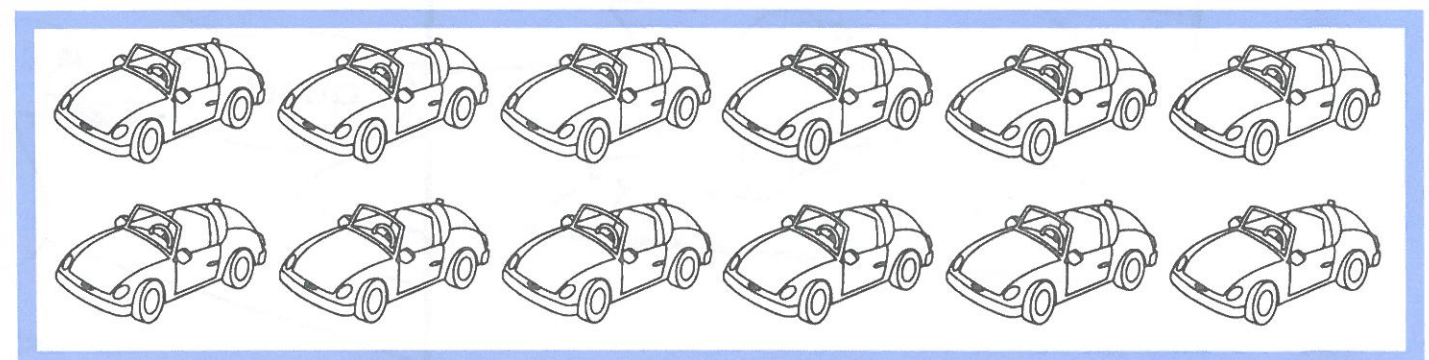
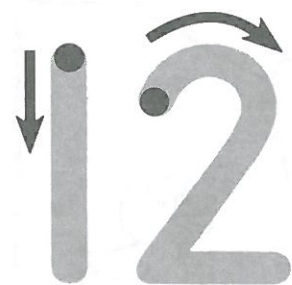
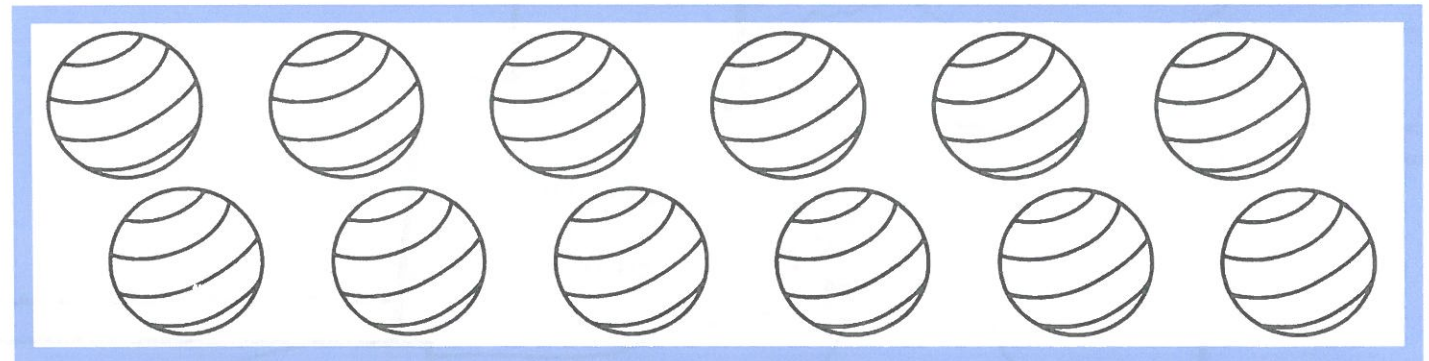
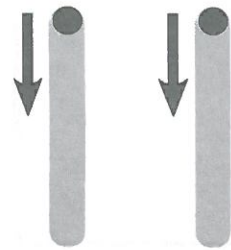
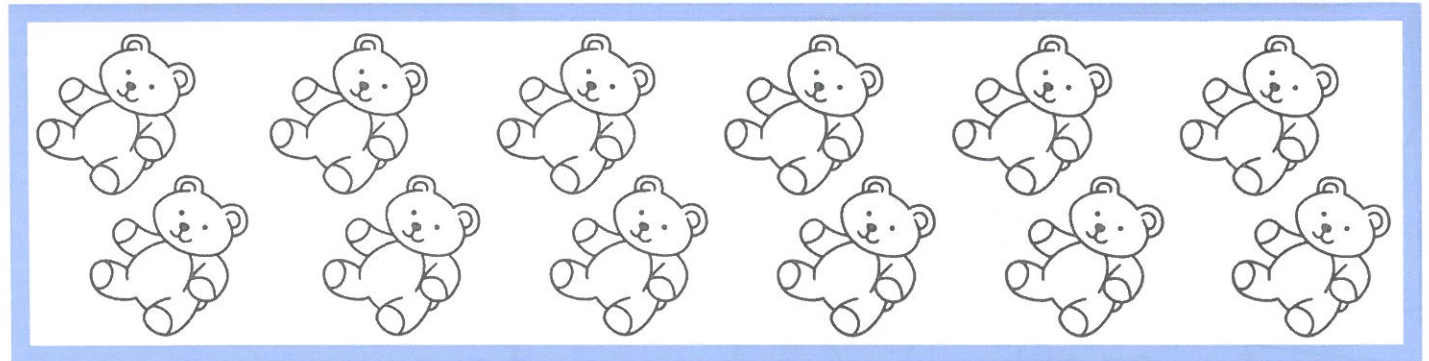
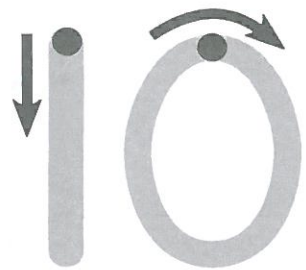

Draw an animal and say the sound.

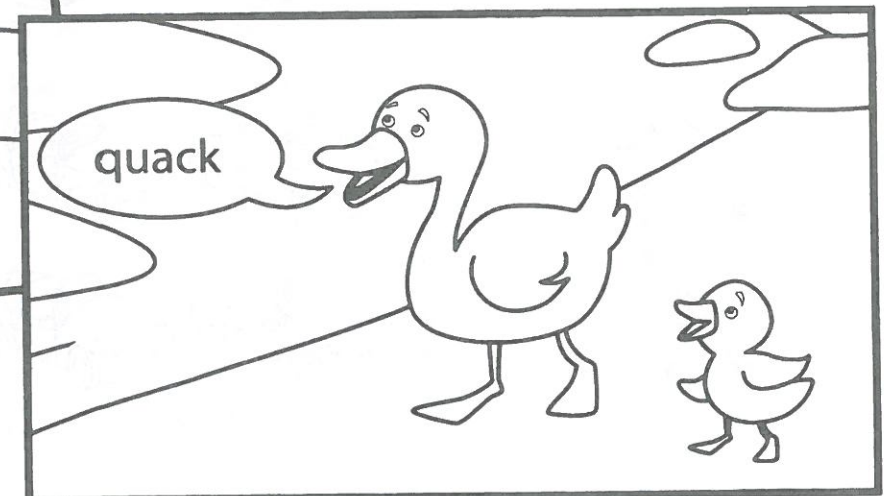



Look and listen. Draw an arrow to the next picture.

# Outdoor Fun

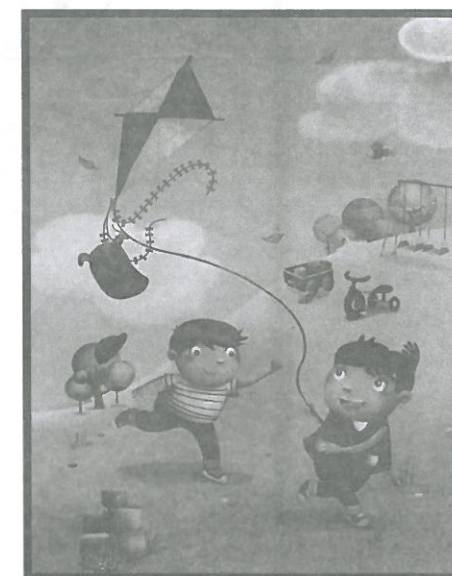
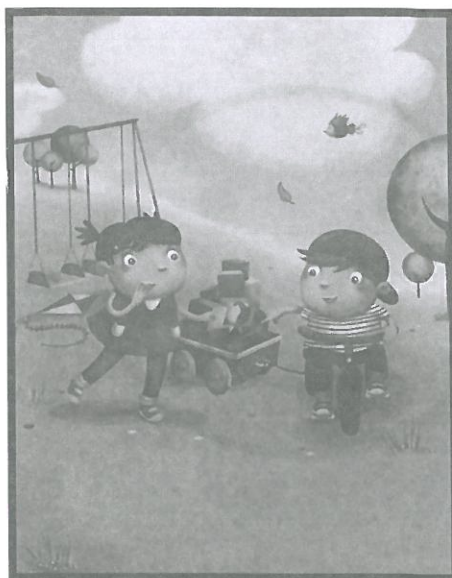



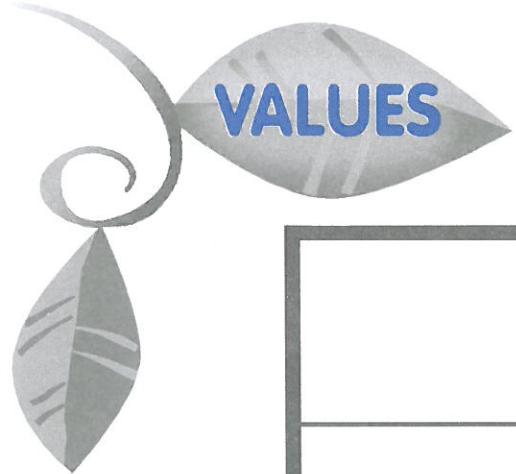

**VALUES**

Are they sharing? Color the correct face.



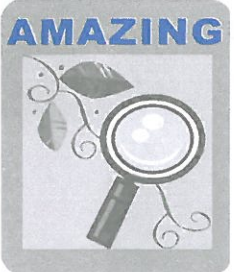

Look. Circle or cross out.

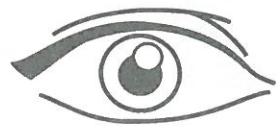

I can see...

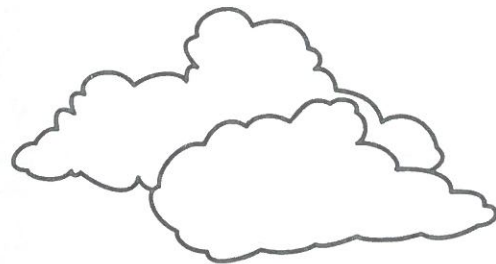

I can hear...

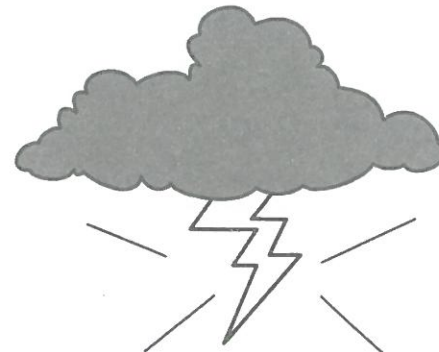
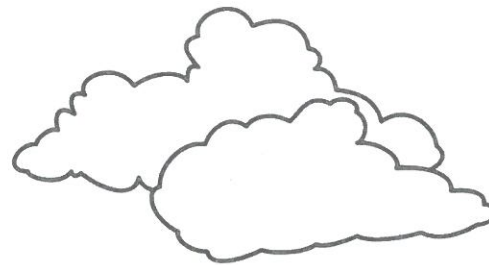

I can touch...

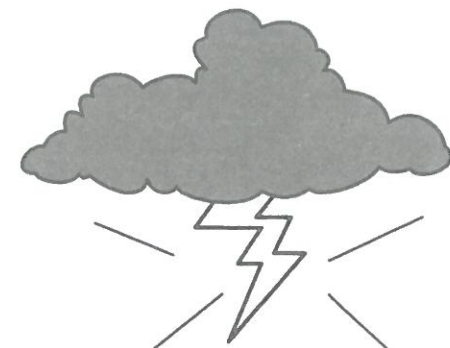
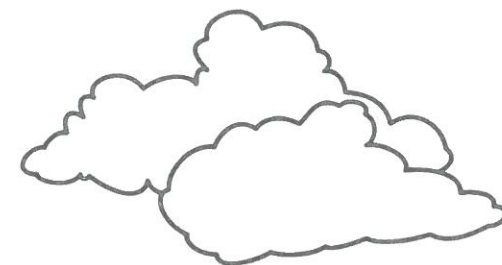

# MY TOYS

Draw your toys.

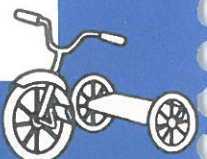
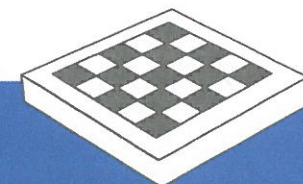
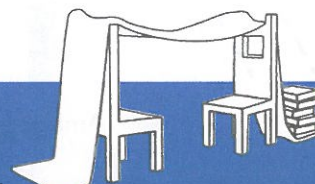
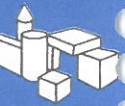
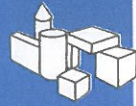
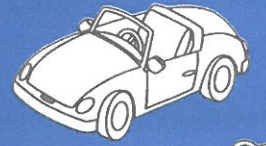



# FOOD

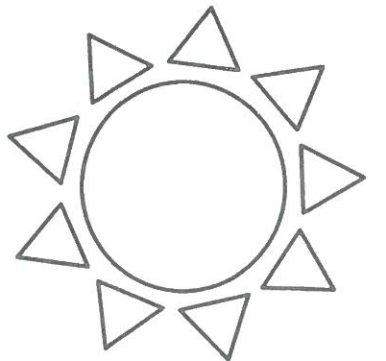

Find and circle. 

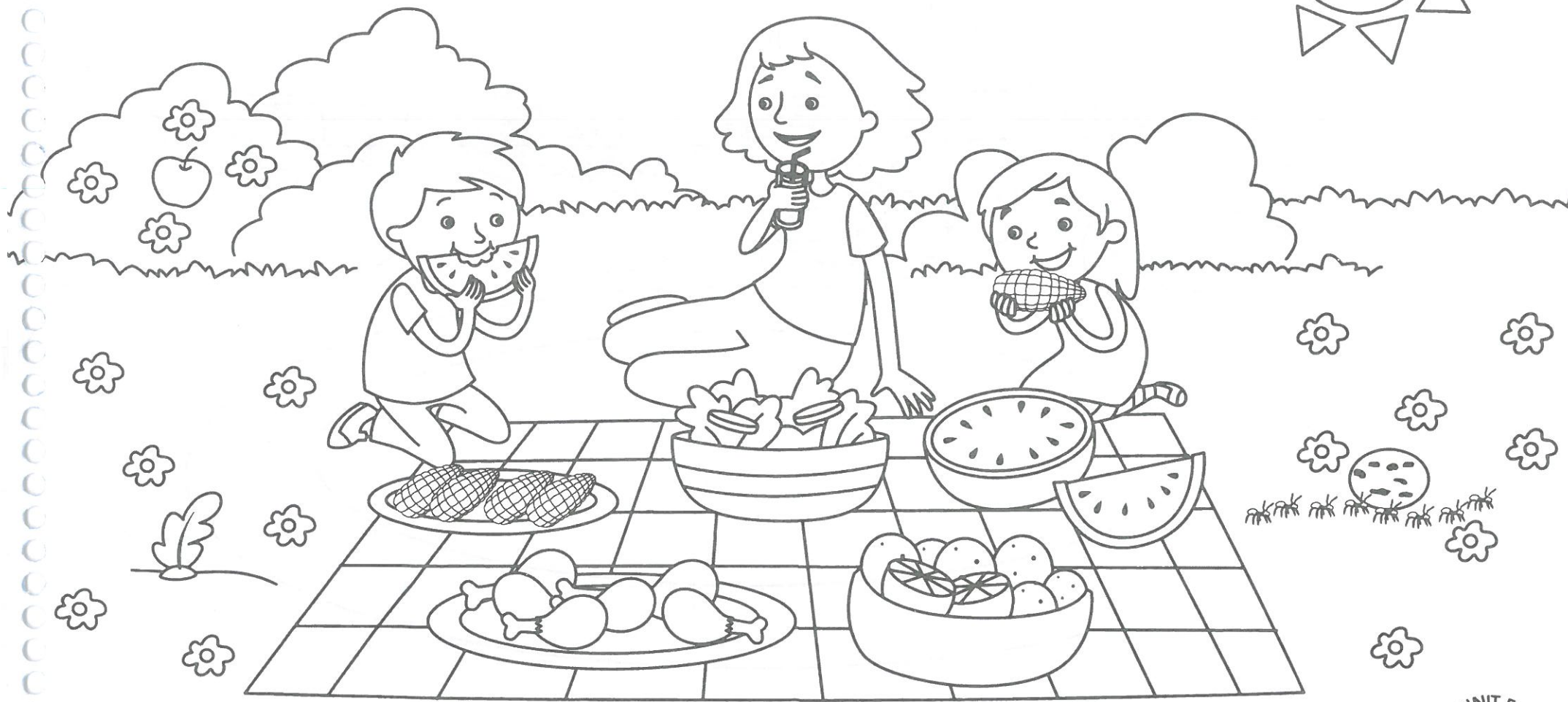

**Point and say. Draw food that you like.**

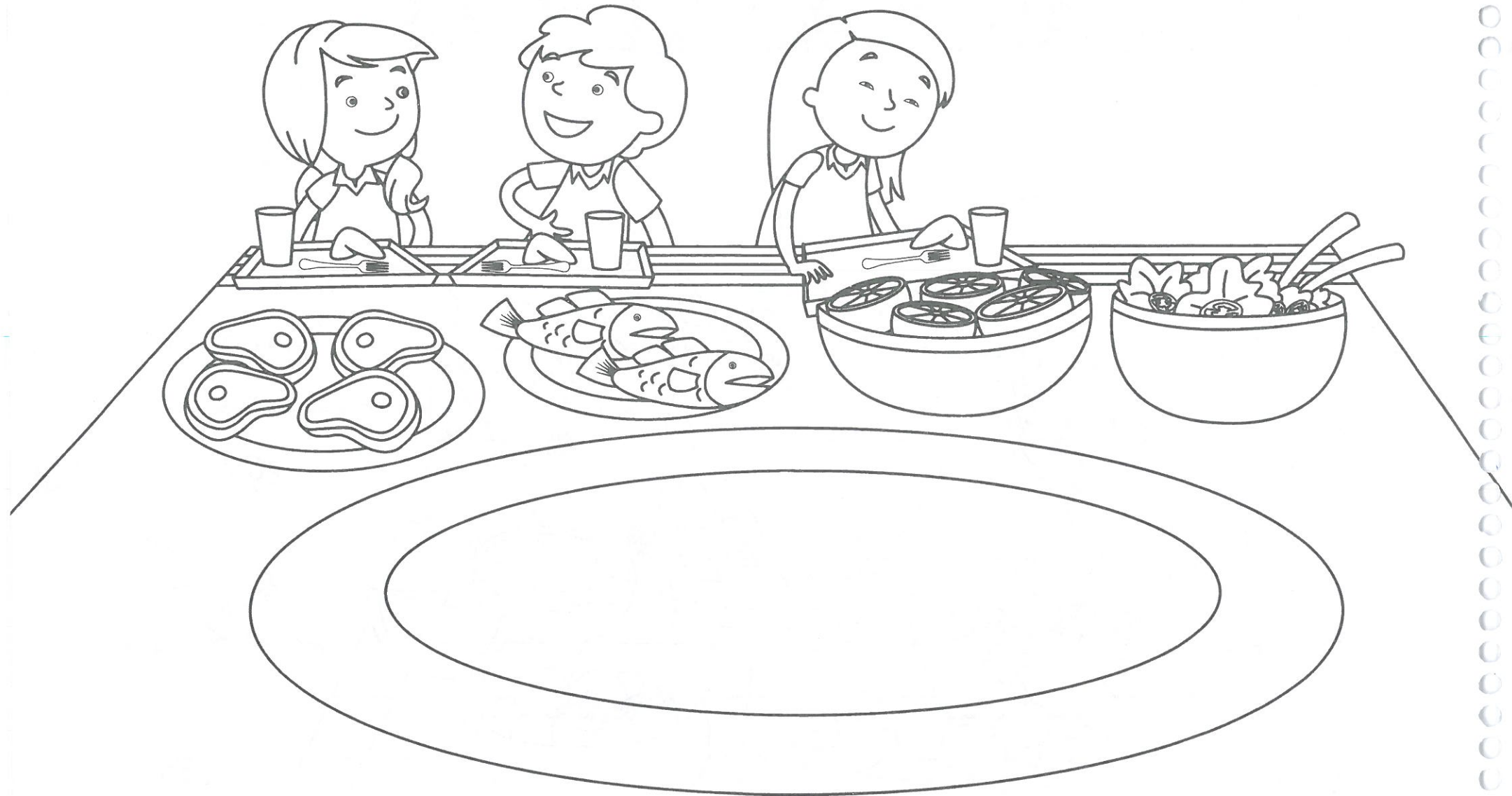



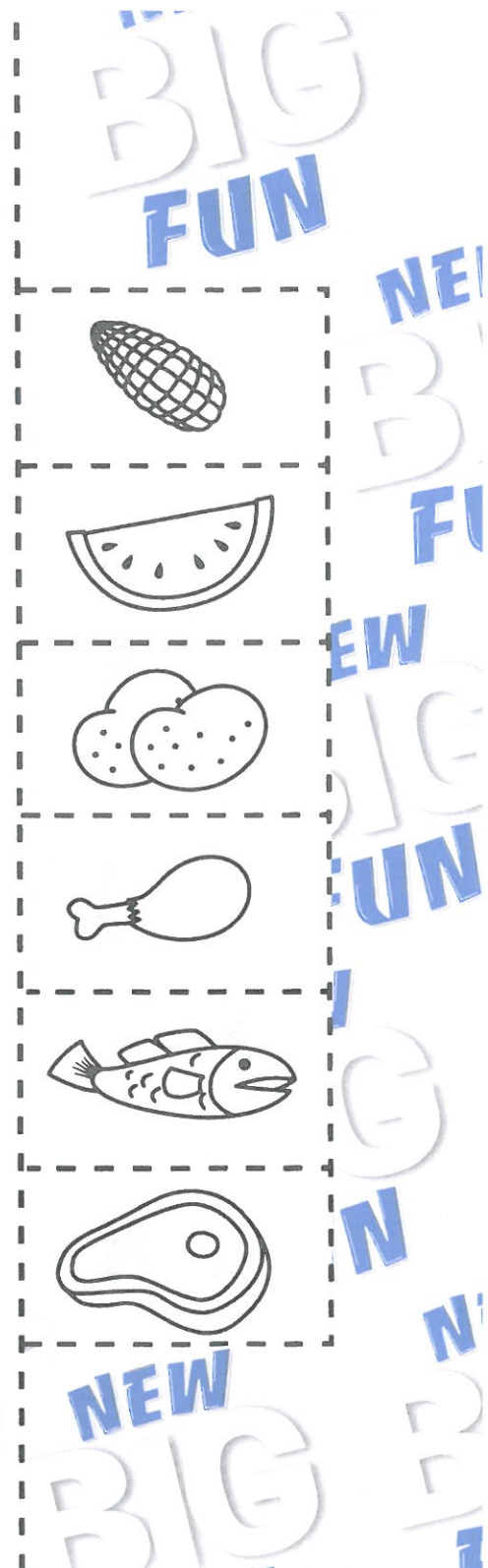
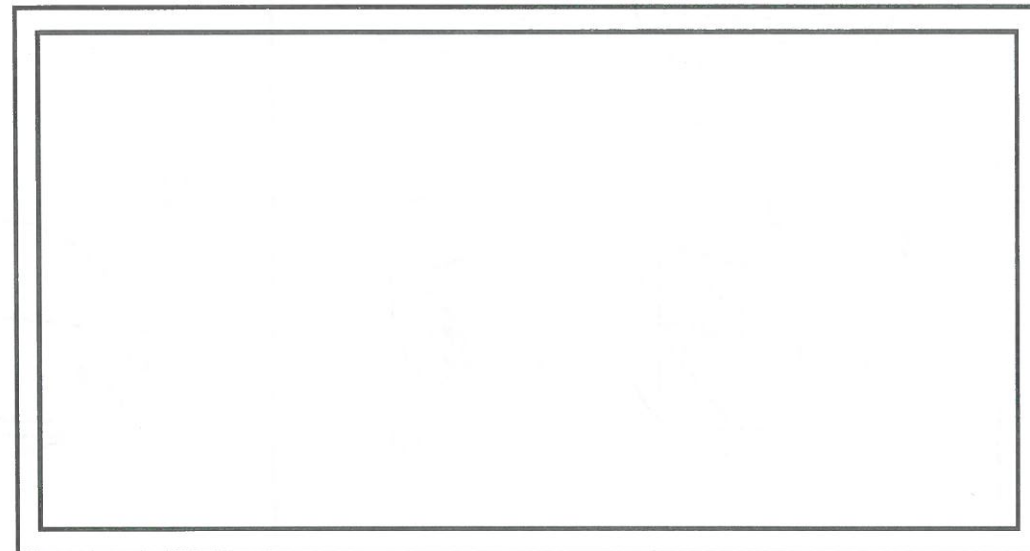
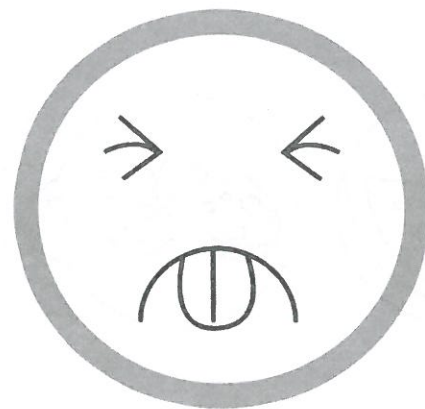
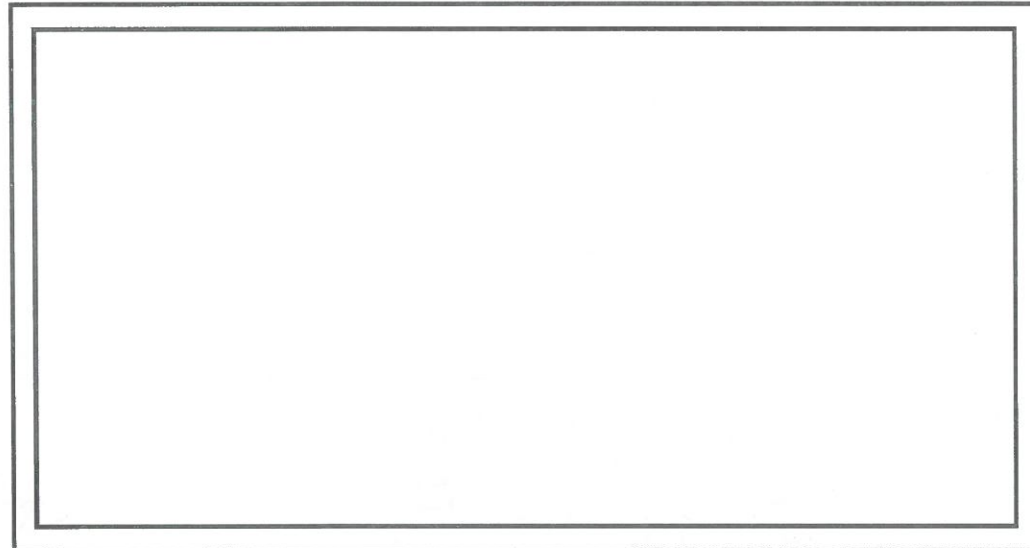
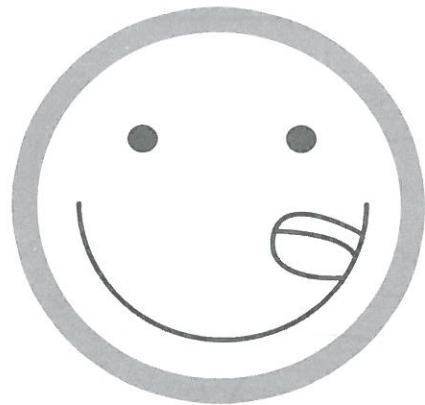

✂ Do you like...? Trace. Then cut out and paste.



BIG FUN  
NEW BIG FUN  
NEW BIG FUN  
NEW BIG FUN  
NEW BIG FUN  
NEW BIG FUN  
NEW BIG FUN  
NEW BIG FUN  
NEW BIG FUN

What do you want to eat? Choose a food or a drink in each section and circle.

LUNCH MENU

1  

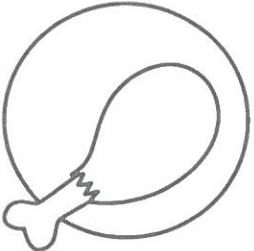
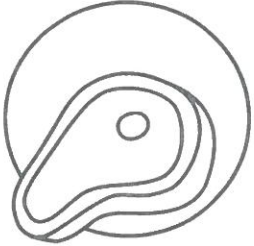
2  

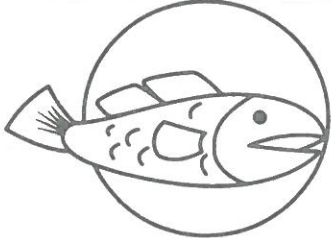

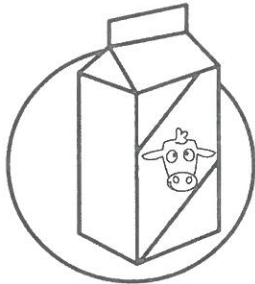
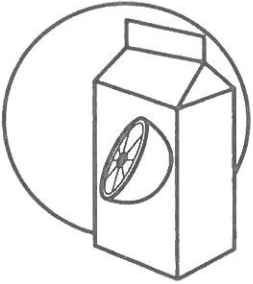
3  

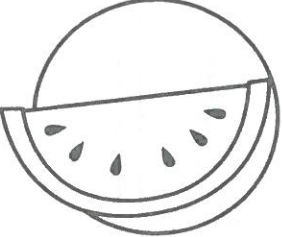
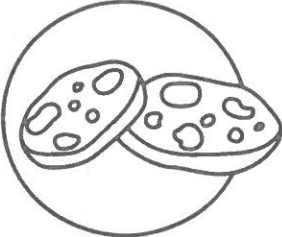
4  

Count and trace.

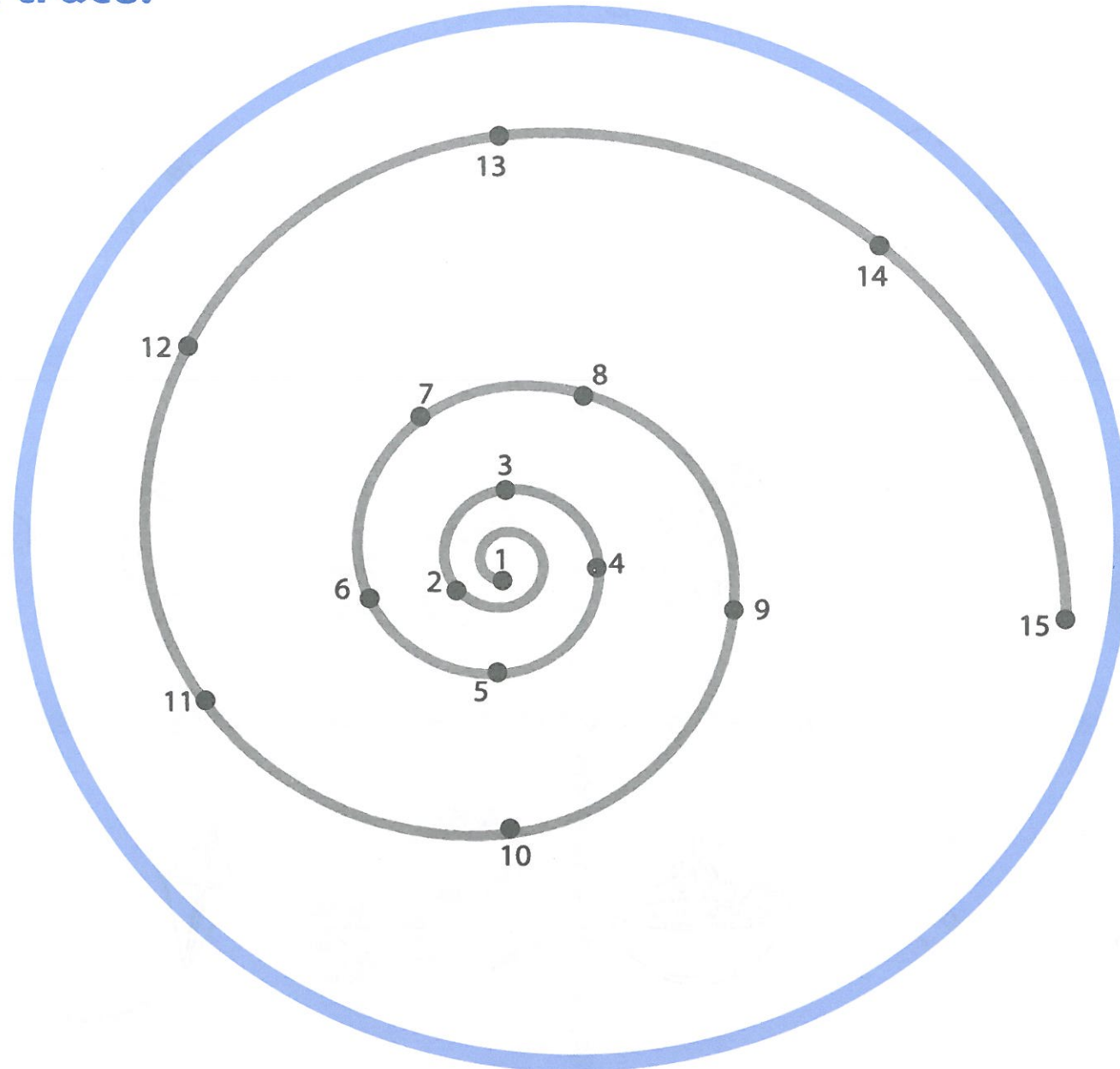



Trace. Circle the items that begin with /s/.

Ss

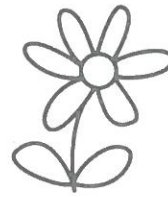
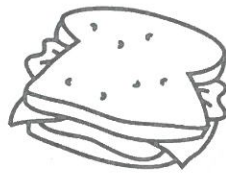

Ss

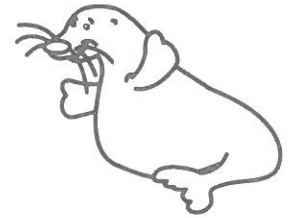
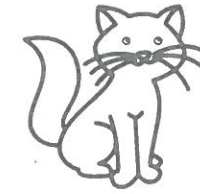

Ss

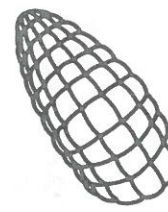

Ss

6



Ss

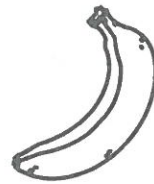

Ss

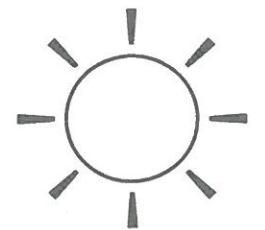



Look and listen. Draw an arrow to the next picture.

# I Like Apples



# VALUES

Are they using table manners?  
Look, trace, and draw a happy or a sad face.

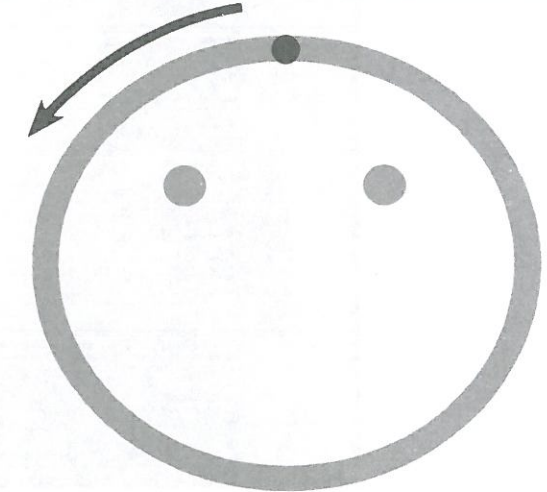
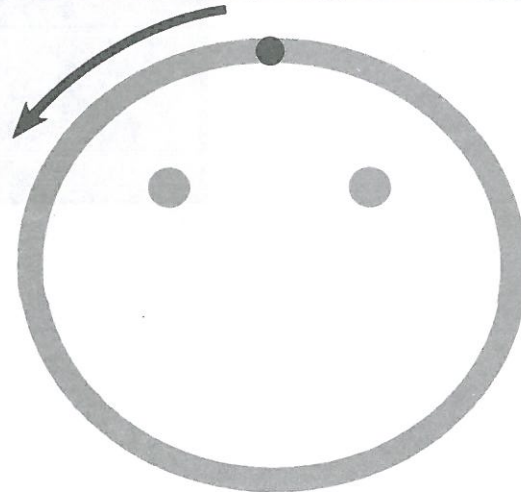
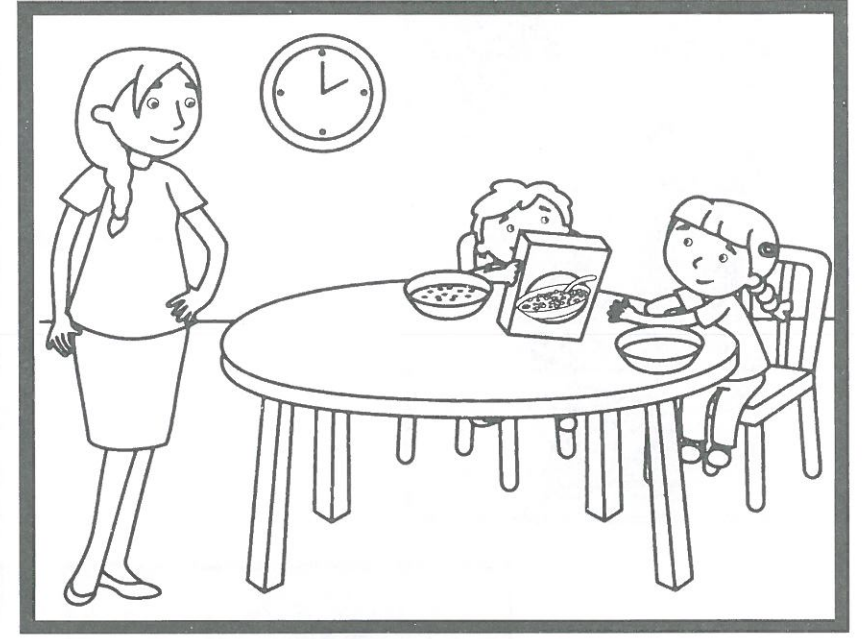
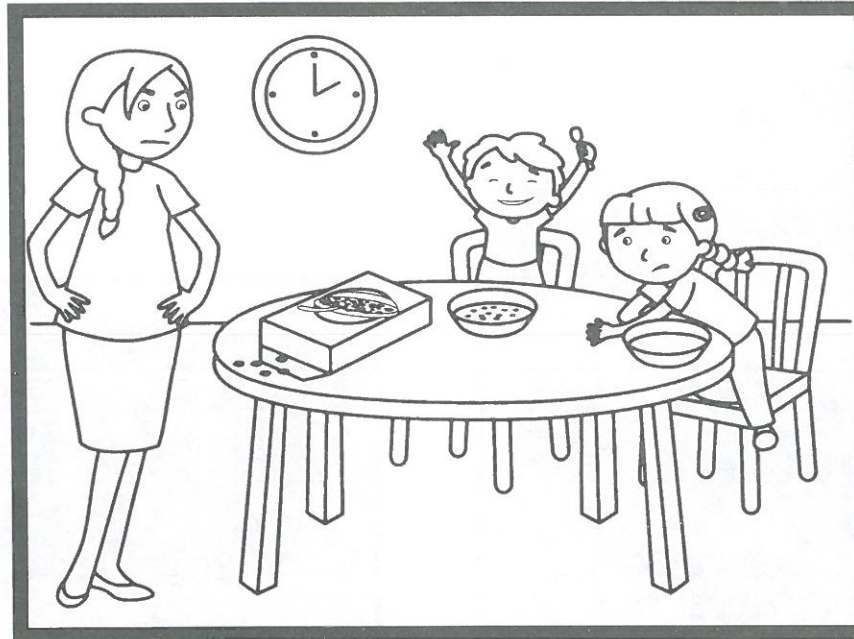

**Color and paste orange tissue paper balls on the tree.**

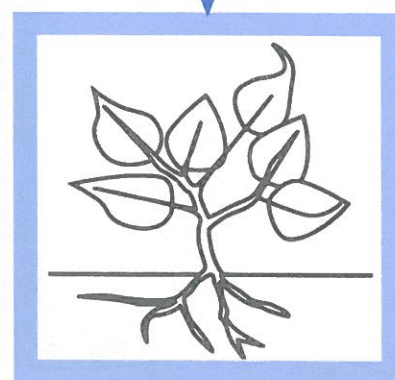
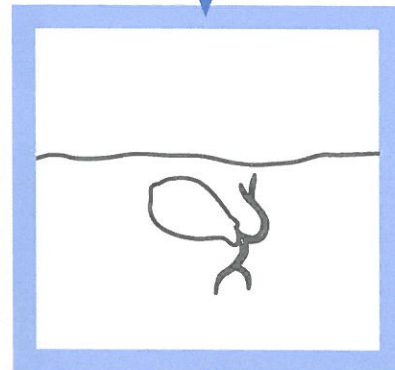
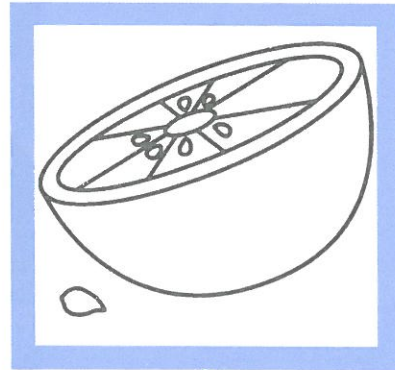

# FOOD

Draw your favorite food.

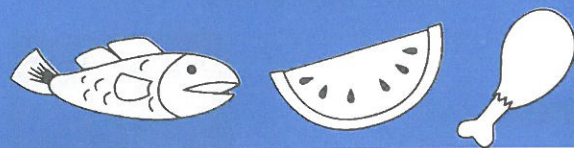

6

# MY CLOTHES

Find and circle. 🐞



Color the crayons. Then trace and color by number.

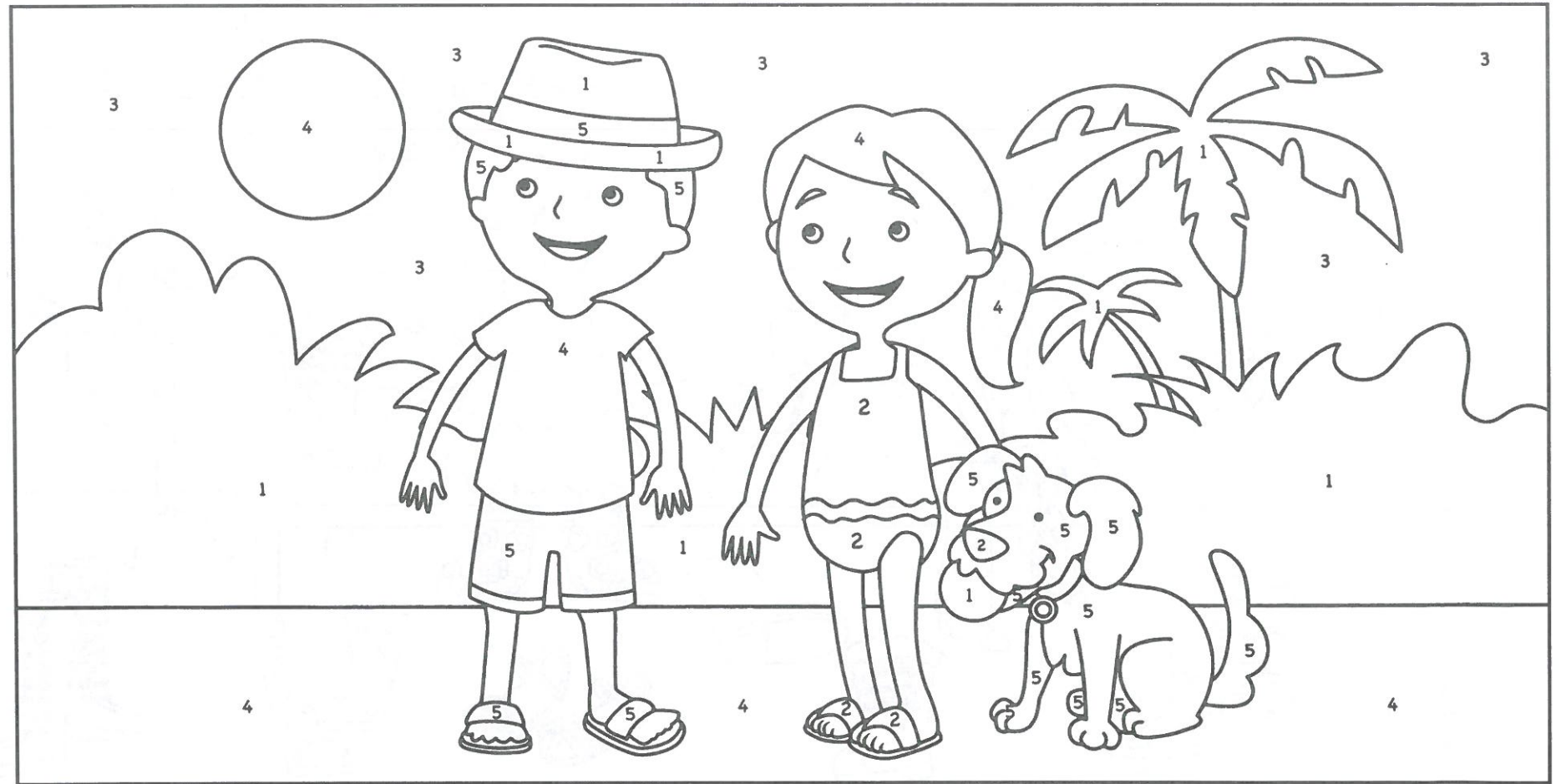
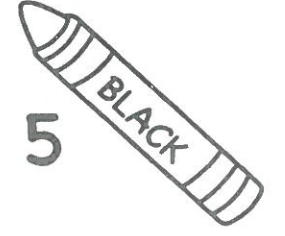
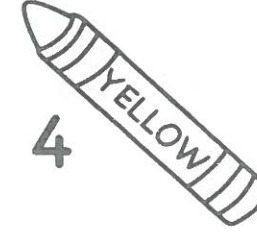
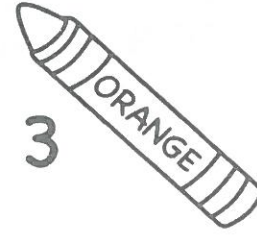
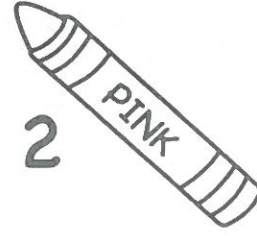
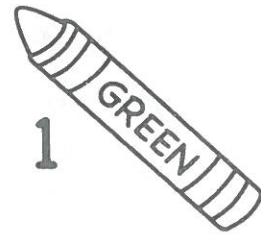

✂️ **Cut out and paste the clothes.**

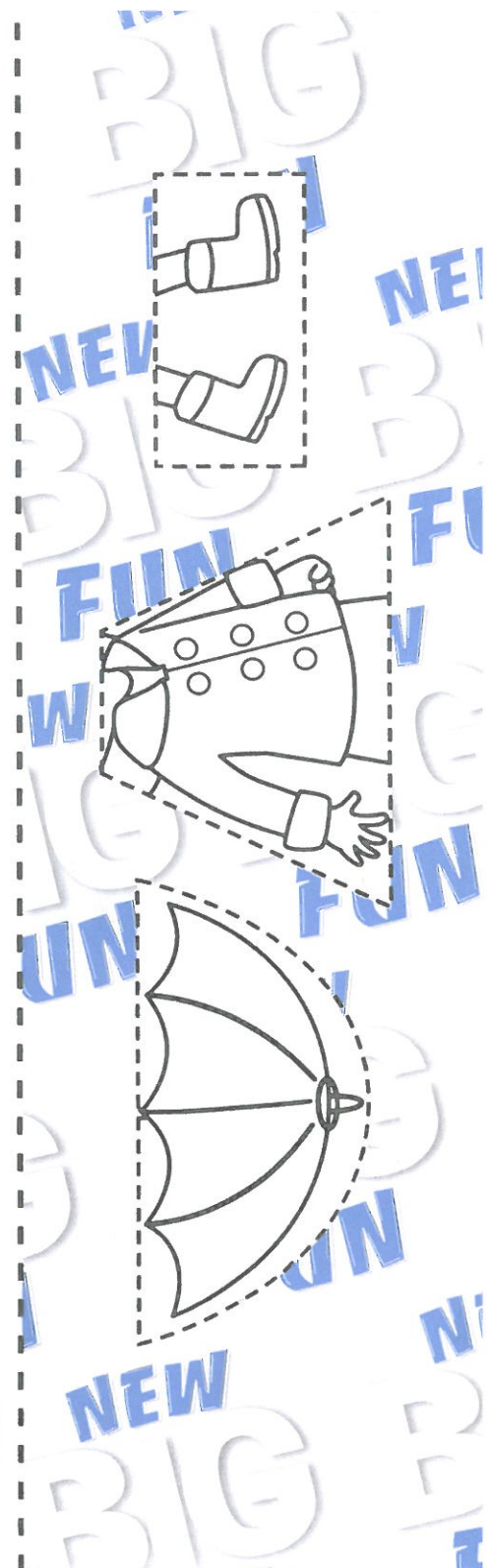

Vocabulary Practice: umbrella, raincoat, boots, jacket



BIG FUN  
NEW  
BIG FUN  
NEW  
BIG FUN  
NEW  
BIG FUN  
NEW  
BIG FUN  
NEW  
BIG FUN  
NEW

Look and draw the weather.

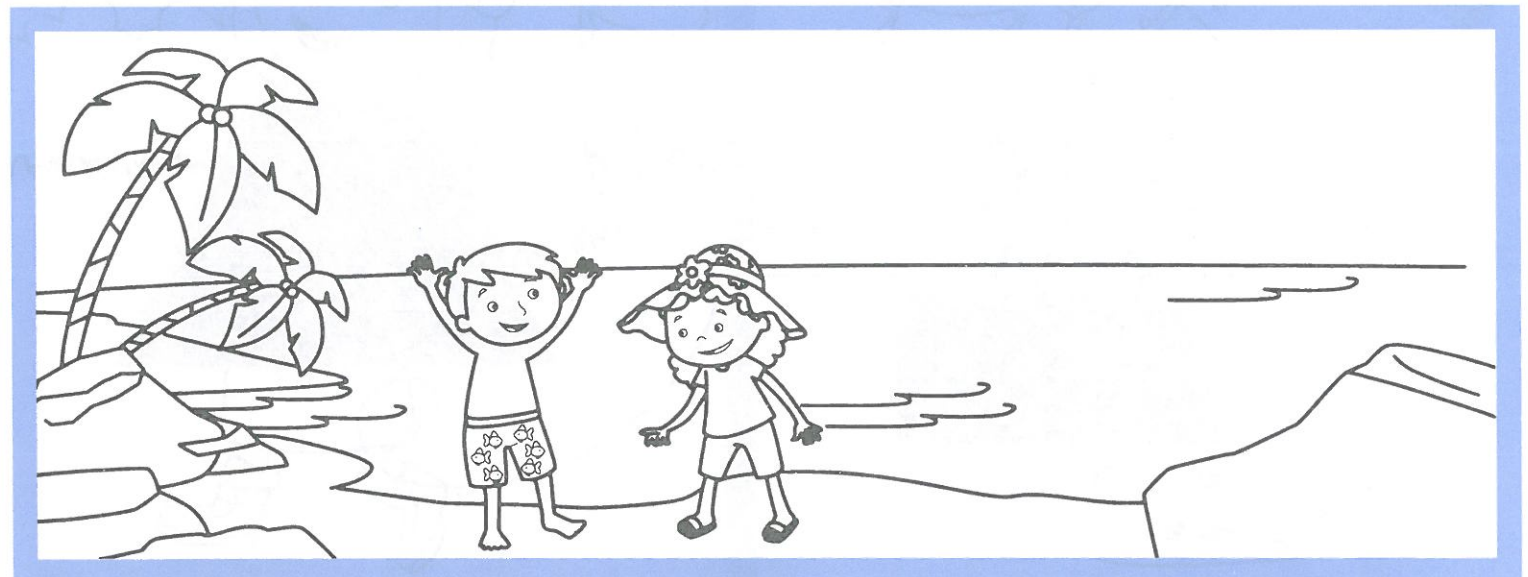

Count and draw one more. Then trace and color.

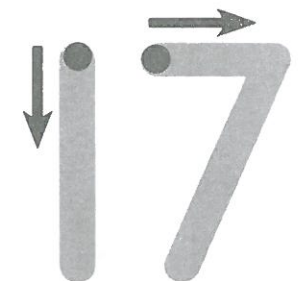
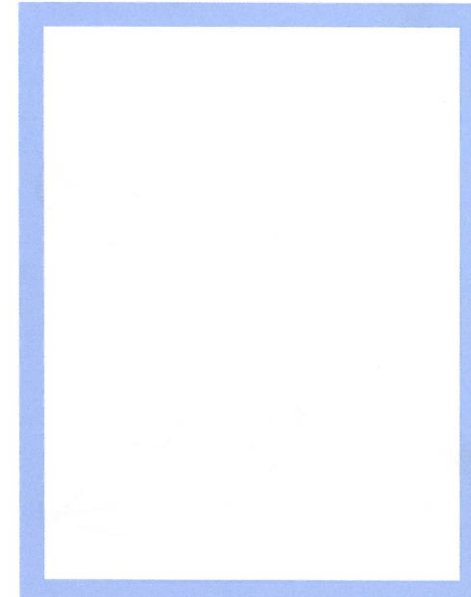
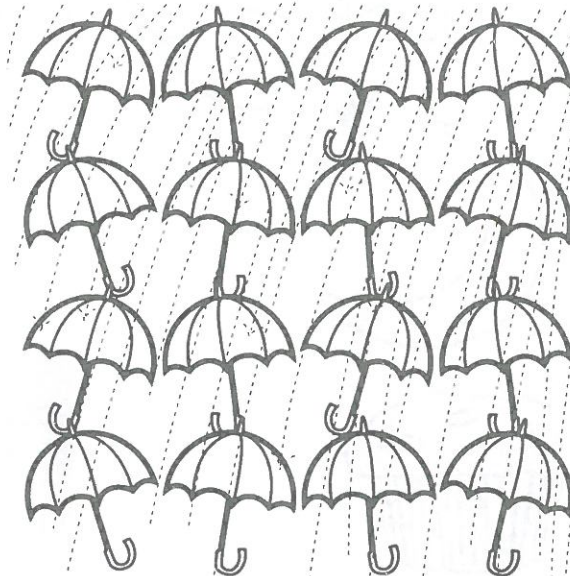
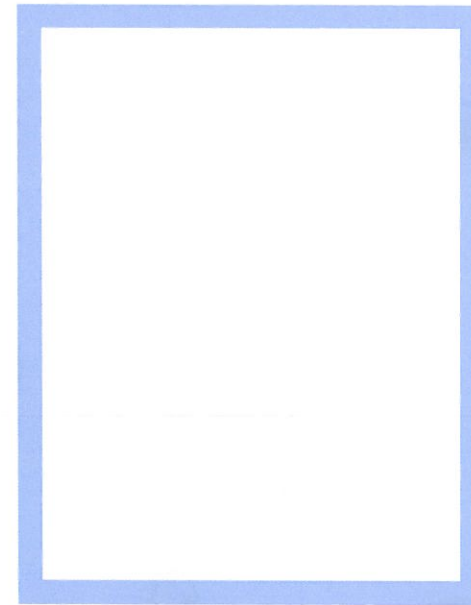
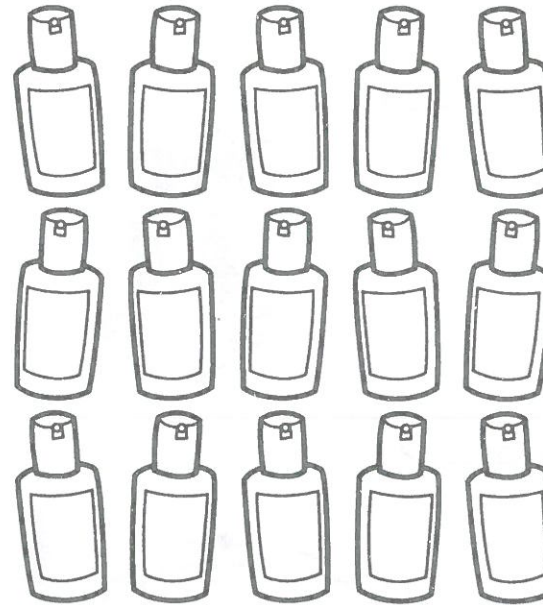
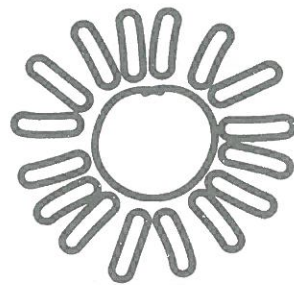

Trace and match with items that begin with /m/.

Mm

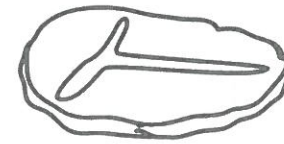

Mm

Mm

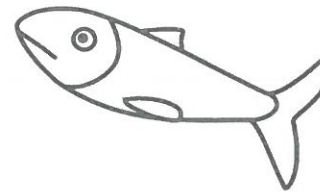

Mm

Mm

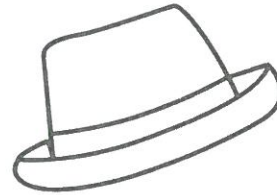

Mm

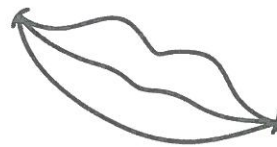



Look and listen. Draw an arrow to the next picture.

# How Many?



**VALUES**

**Who is helping? Look and match.**

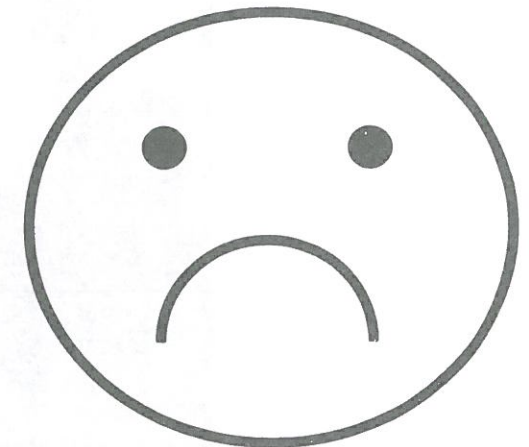
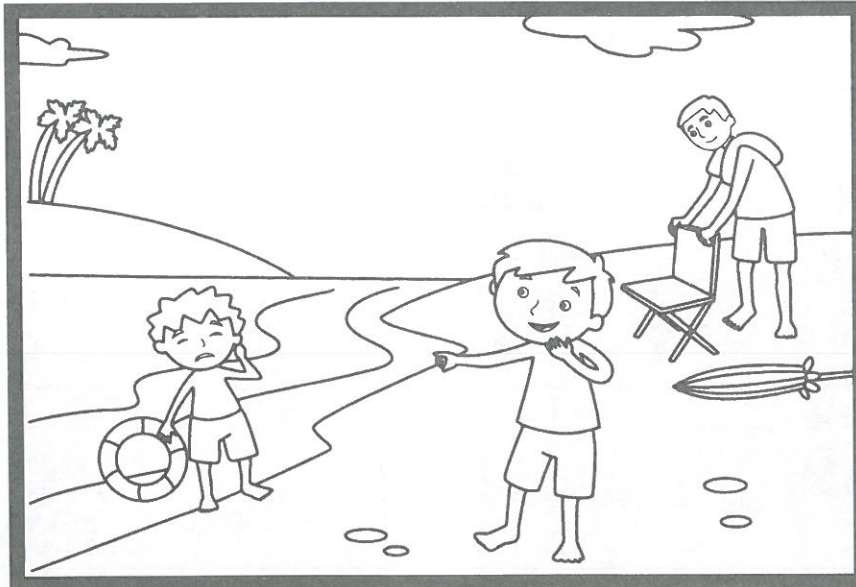

Color and paste brightly colored paper feathers.

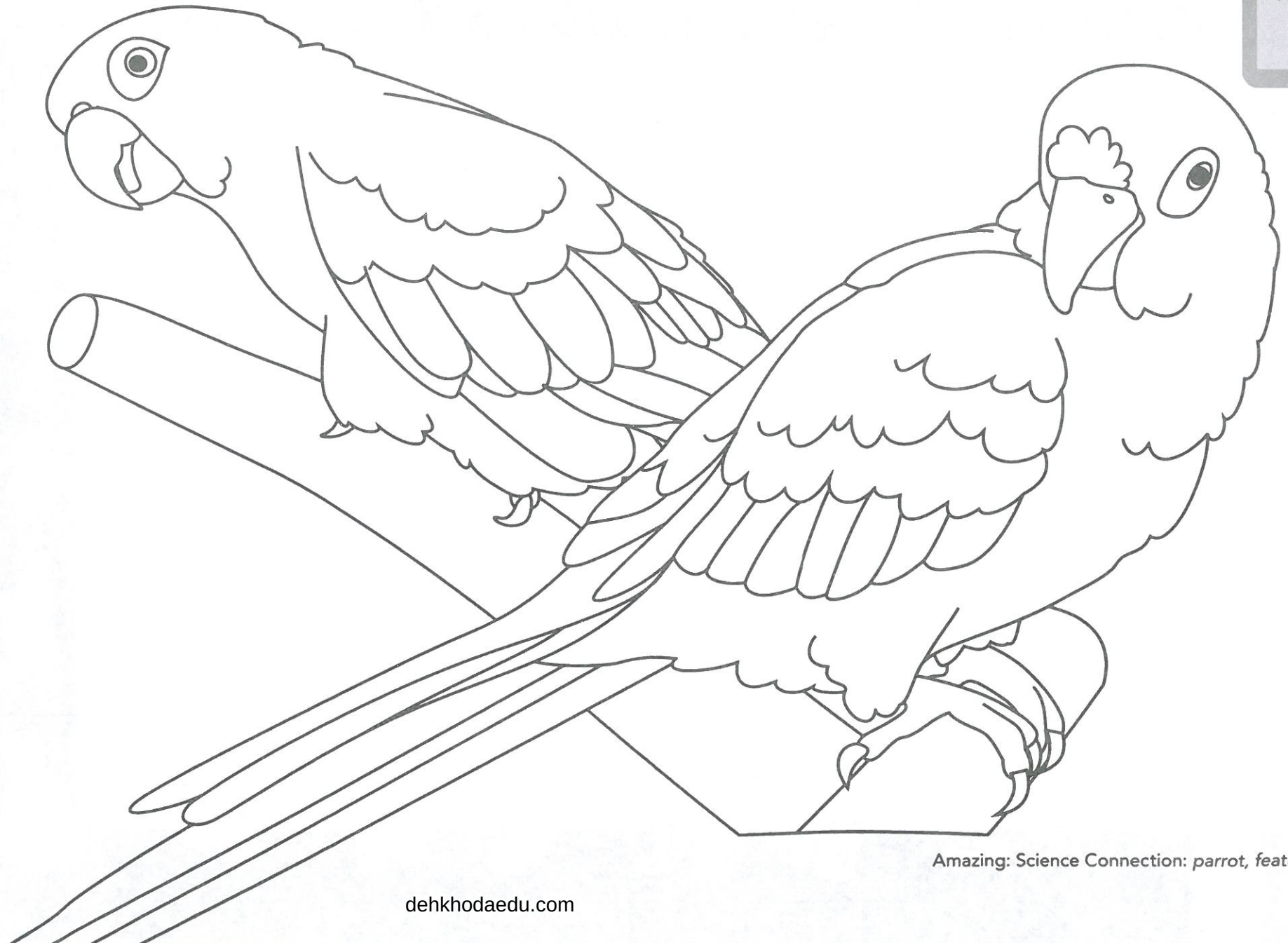
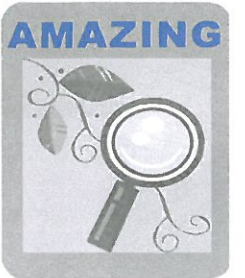

# MY CLOTHES

Draw your favorite clothes.



7

# ANIMALS

Find and circle. 

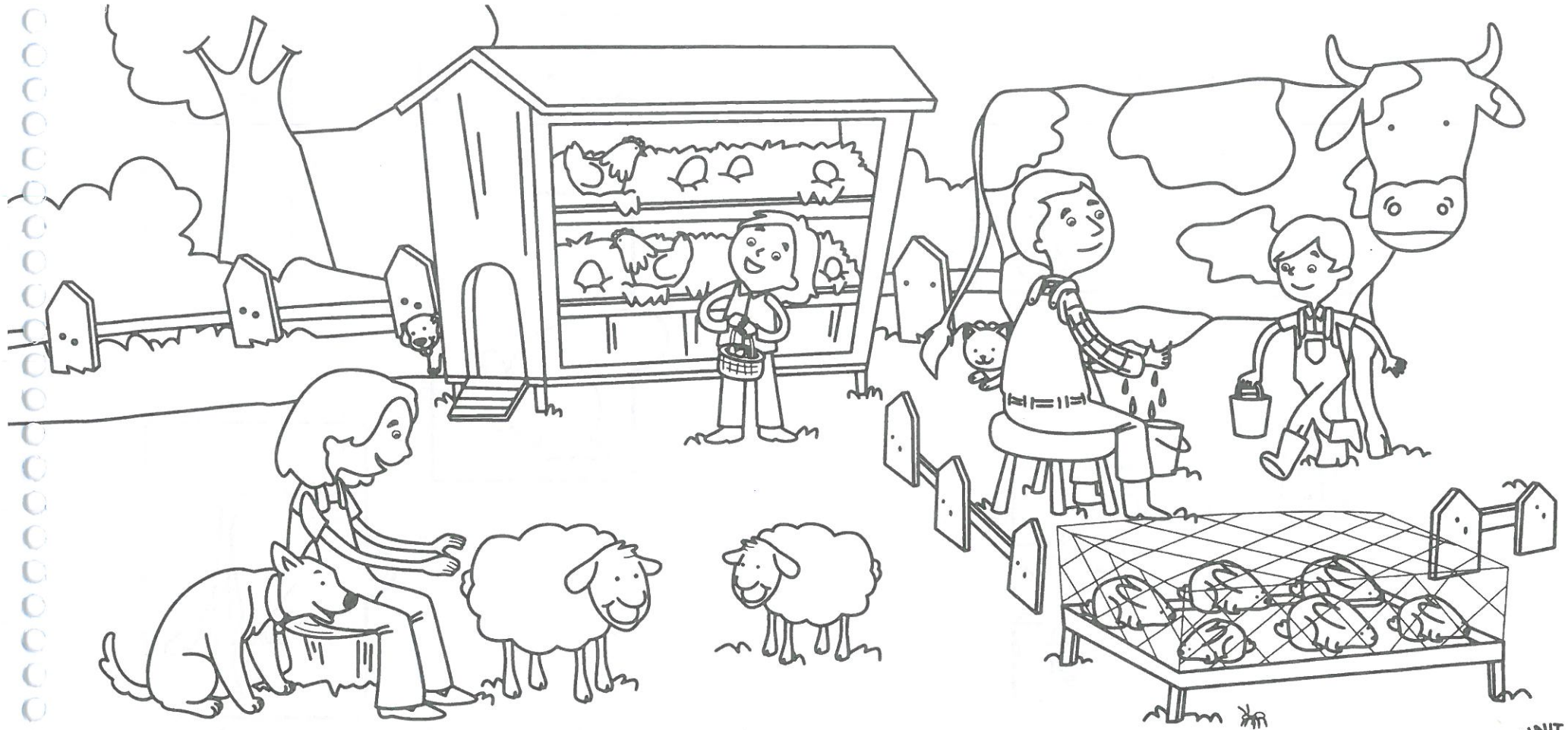





موسسه زبان دهخدا  
dekhodaedu.com

### Match and color.

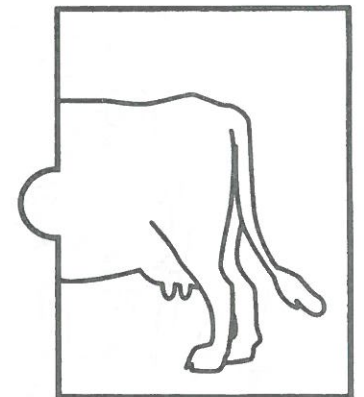
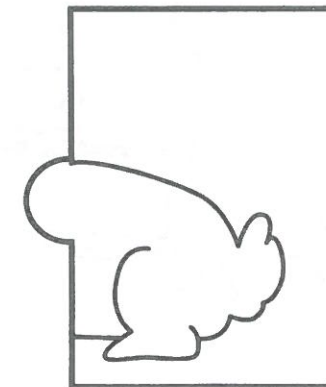
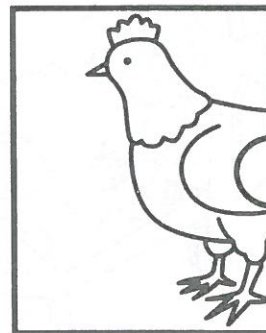
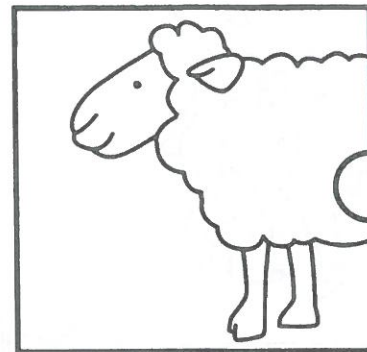
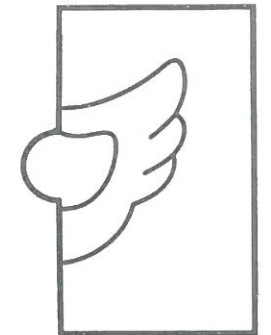
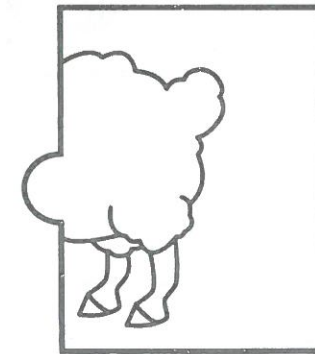
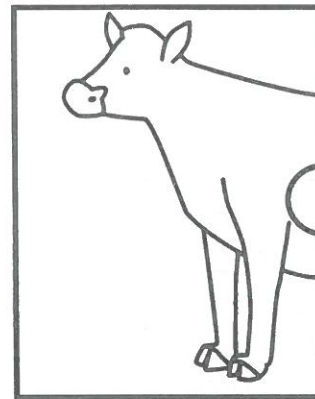



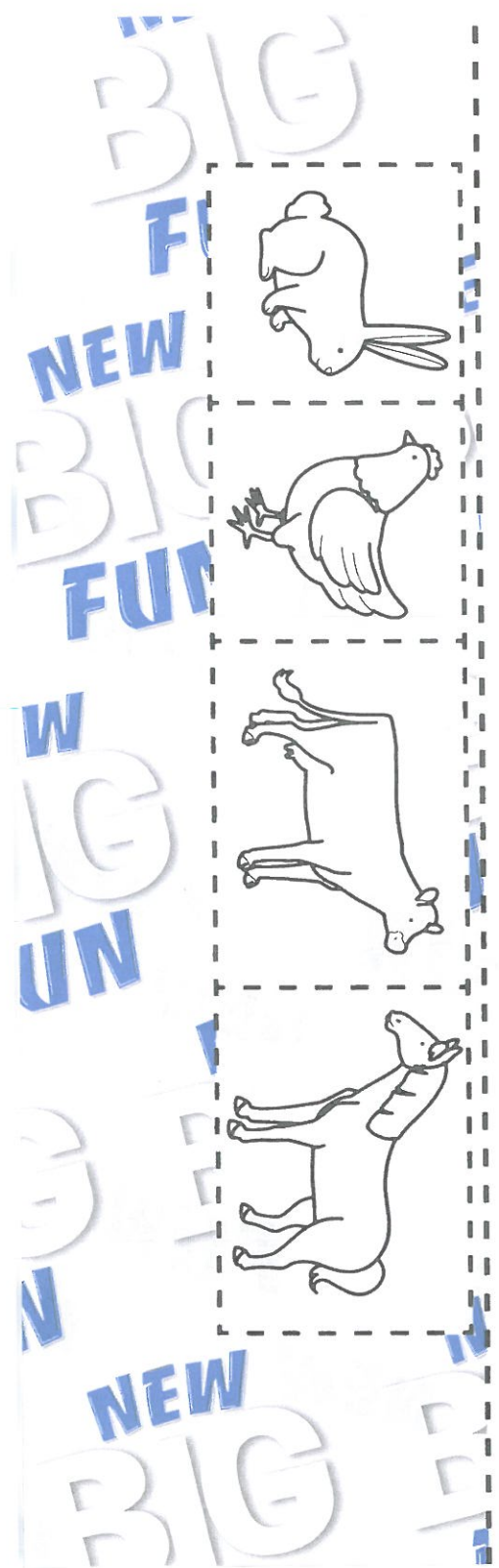

✂ **Cut out and paste two animals. Say.**

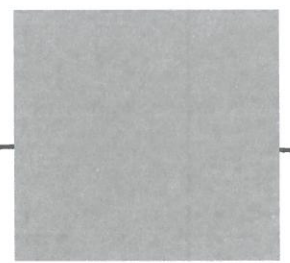
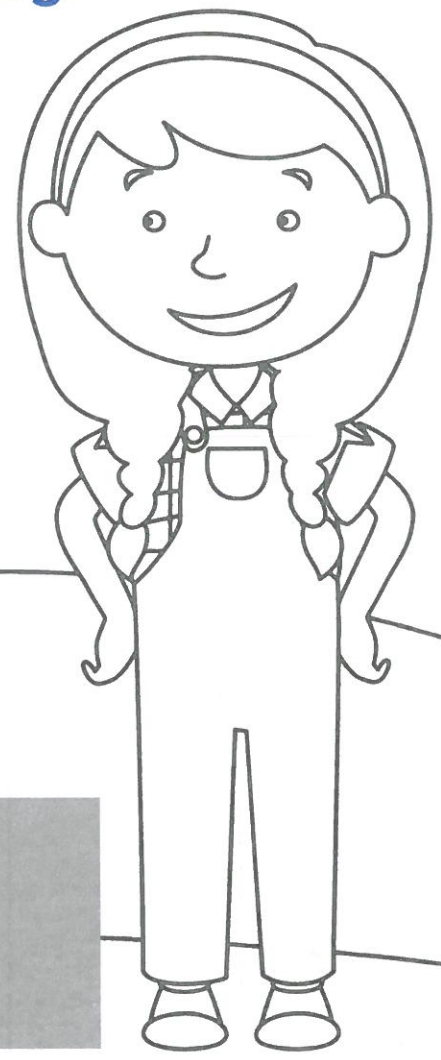
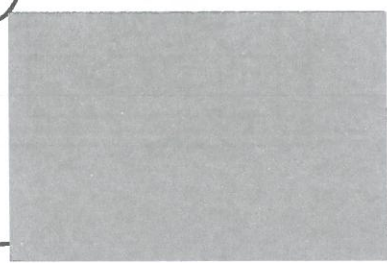
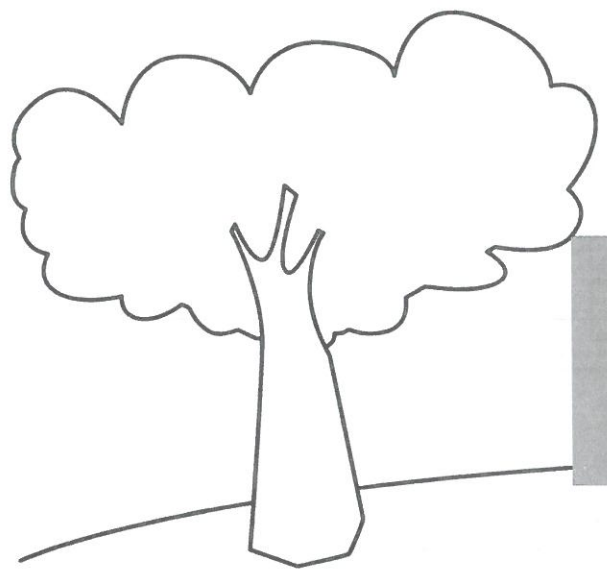

Connect the dots and color. Draw your favorite pet.

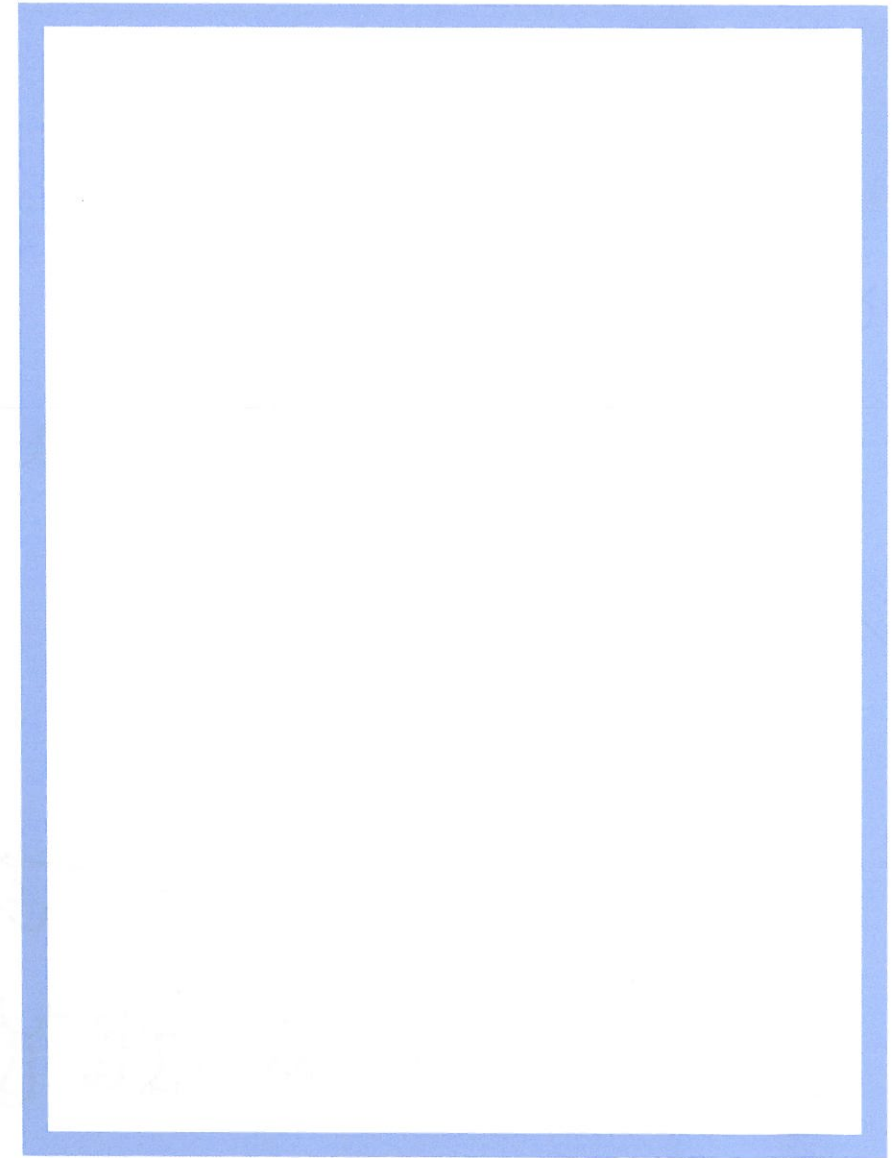

Trace and write. Color things that begin with /l/.

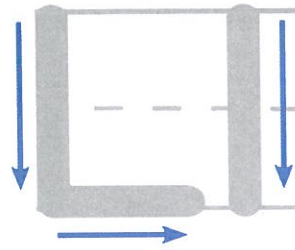



Look and listen. Draw an arrow to the next picture.

# Where Are the Lambs?

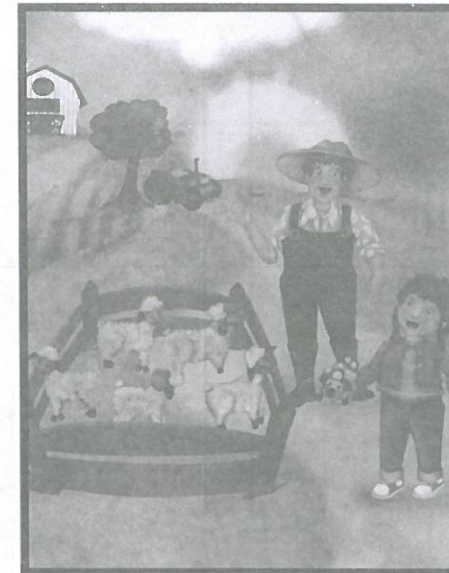

**VALUES**

**Are they taking care of the animals?  
Color the correct face.**

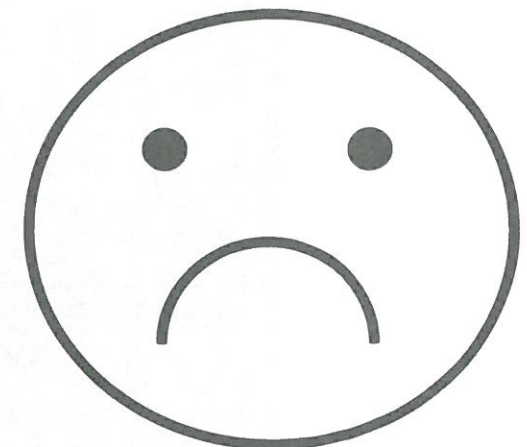
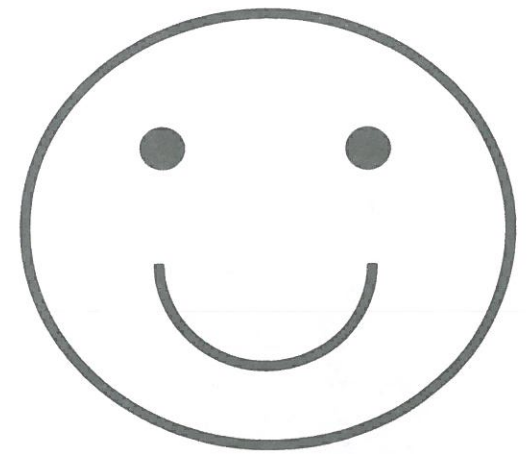

Number, trace, and draw a chick in the broken eggshell.

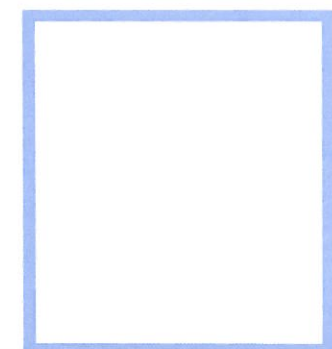
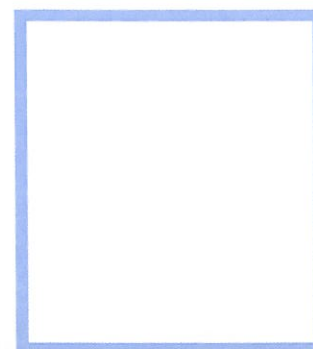
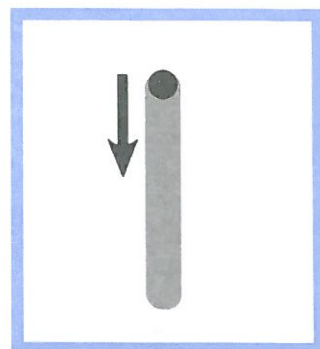
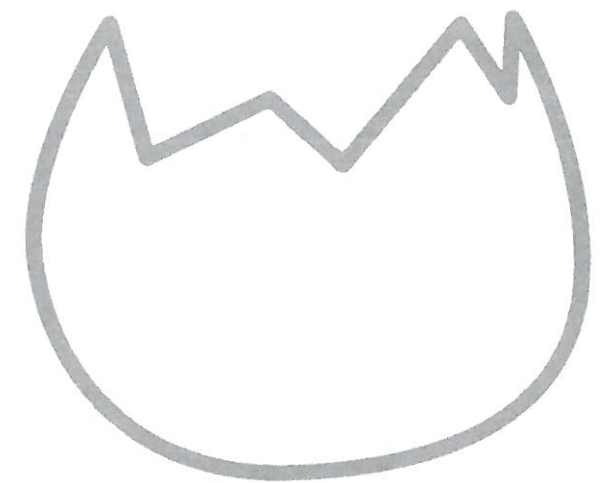
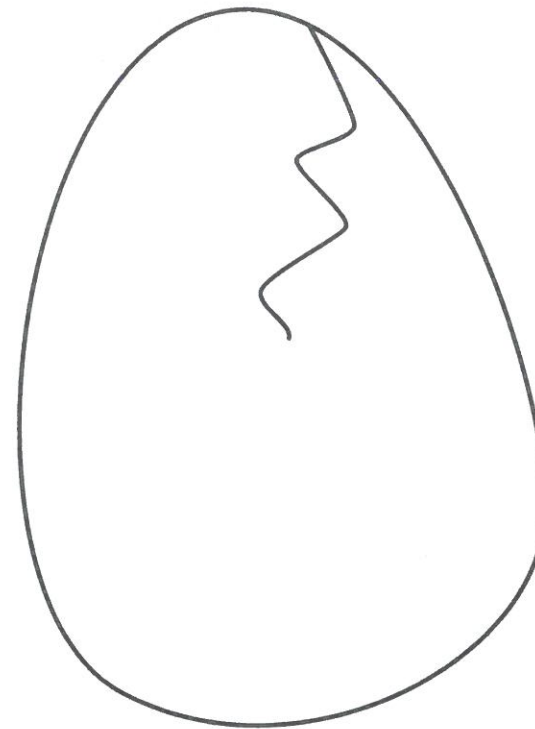
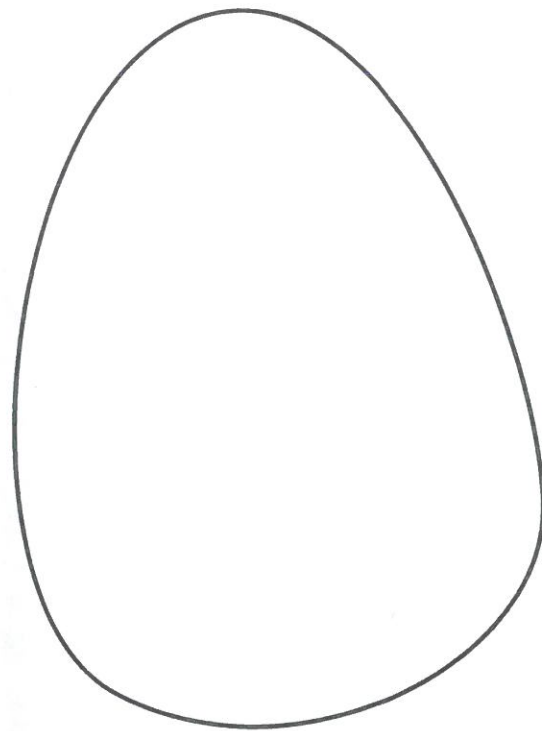



# ANIMALS

Draw your favorite farm animals.



# 8

# MY WORLD

Find and circle. 

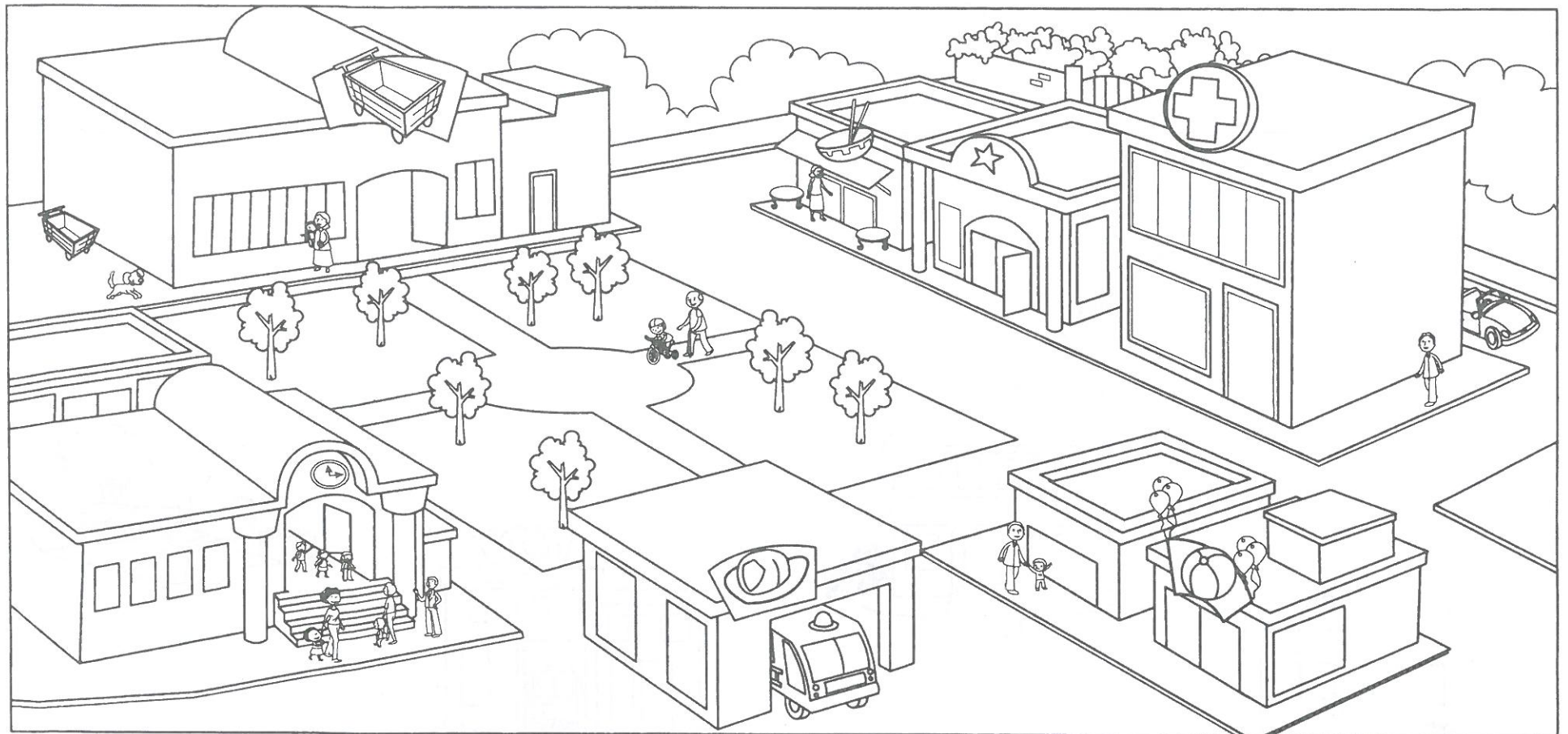

Where are they? Look and match.

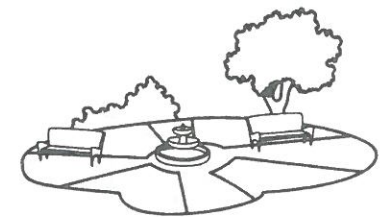
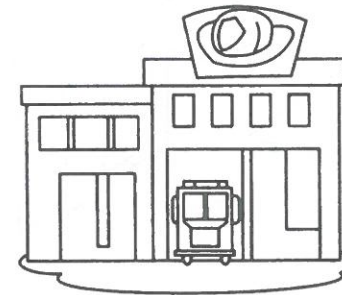
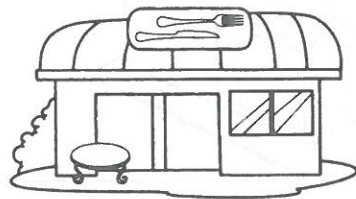
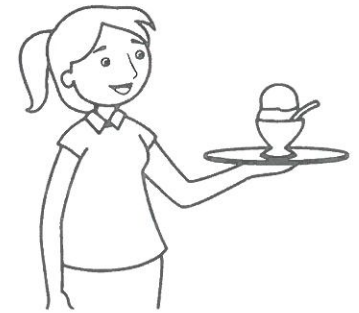
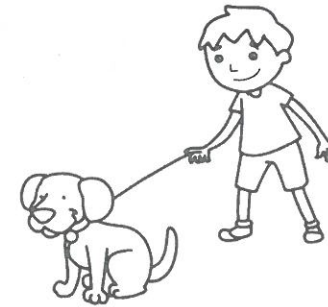

 **Cut out and paste the places. Say.**

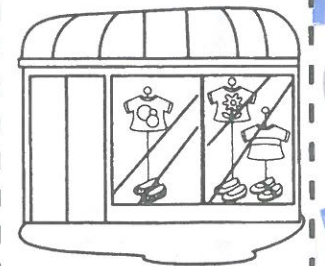
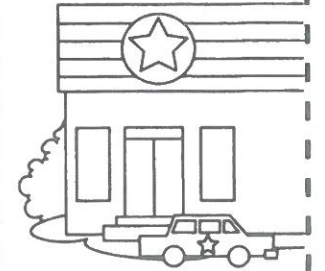
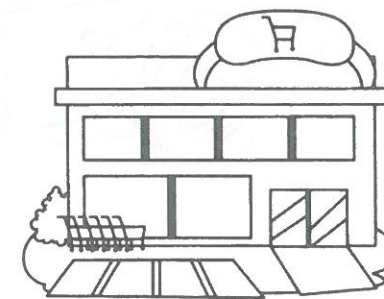
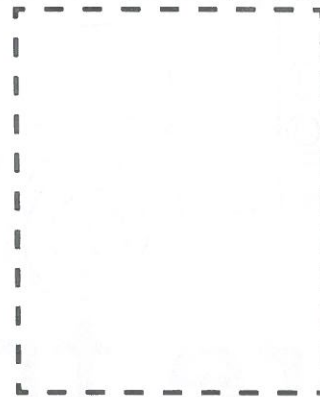
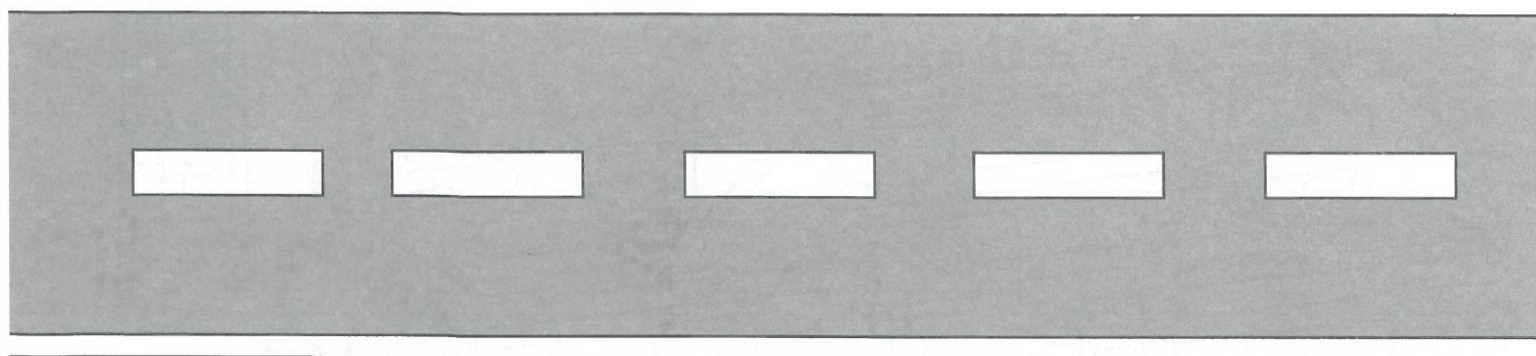
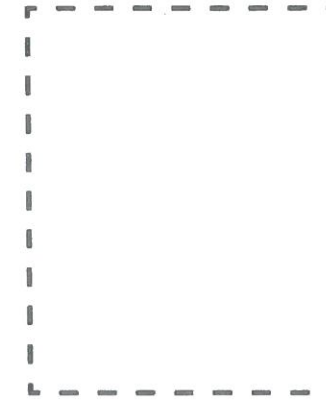
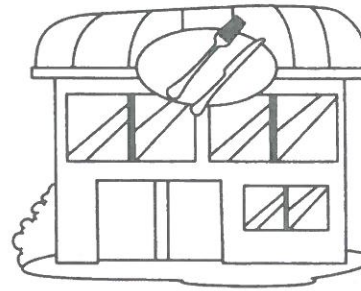
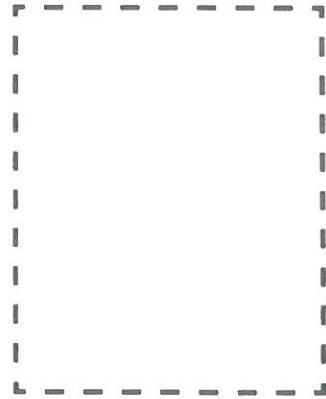

Vocabulary Practice: *police station, hospital, store, restaurant, school, supermarket*  
Language Practice: *The (hospital) is (next to) the (school).*

BIG FUN  
NEW  
BIG FUN  
NEW  
BIG FUN  
NEW  
BIG FUN  
NEW  
BIG FUN  
NEW  
BIG FUN  
NEW

Draw a person or pet in the window. Trace and color.

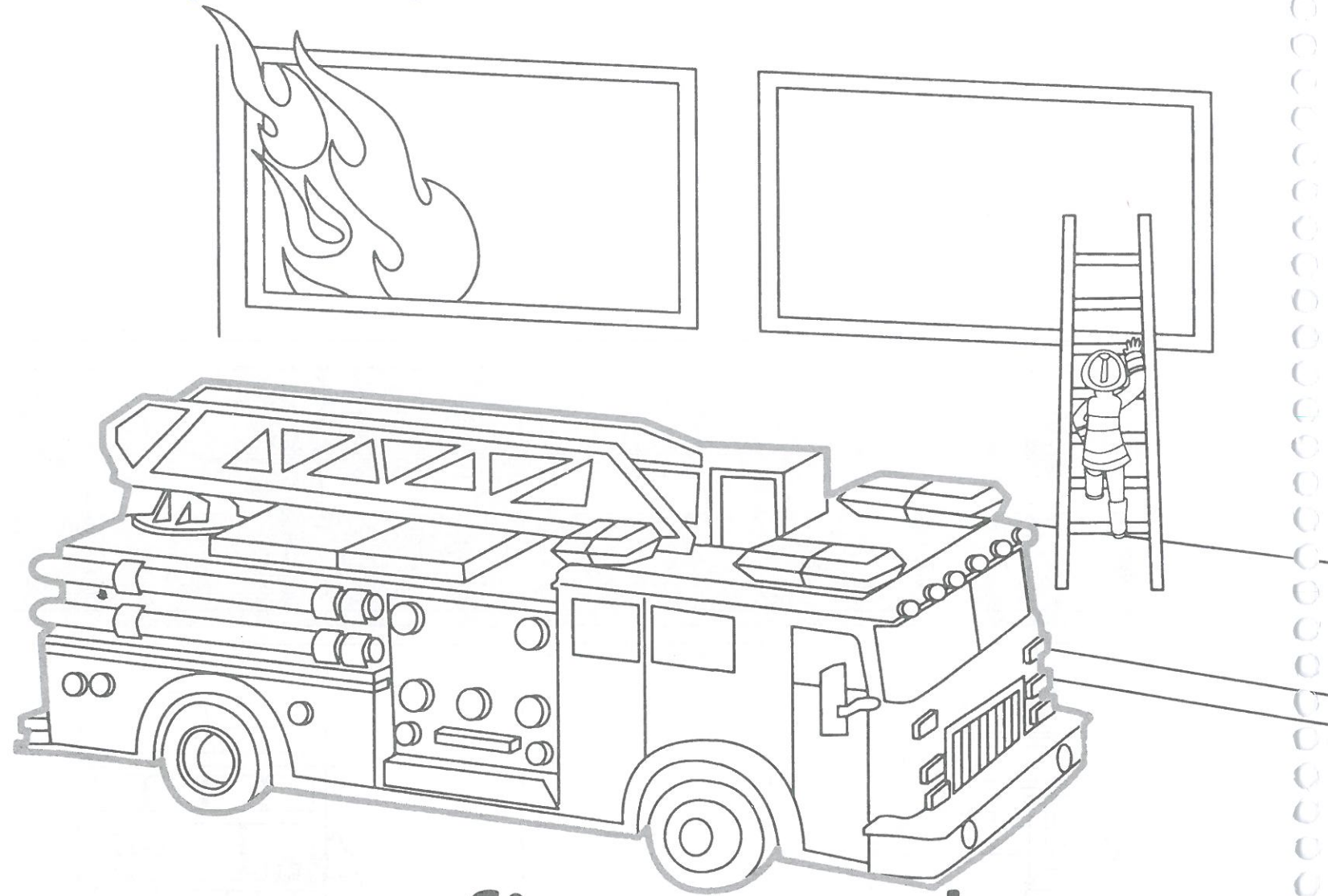

fire truck

Count and color 20 fire trucks. Complete the number line.

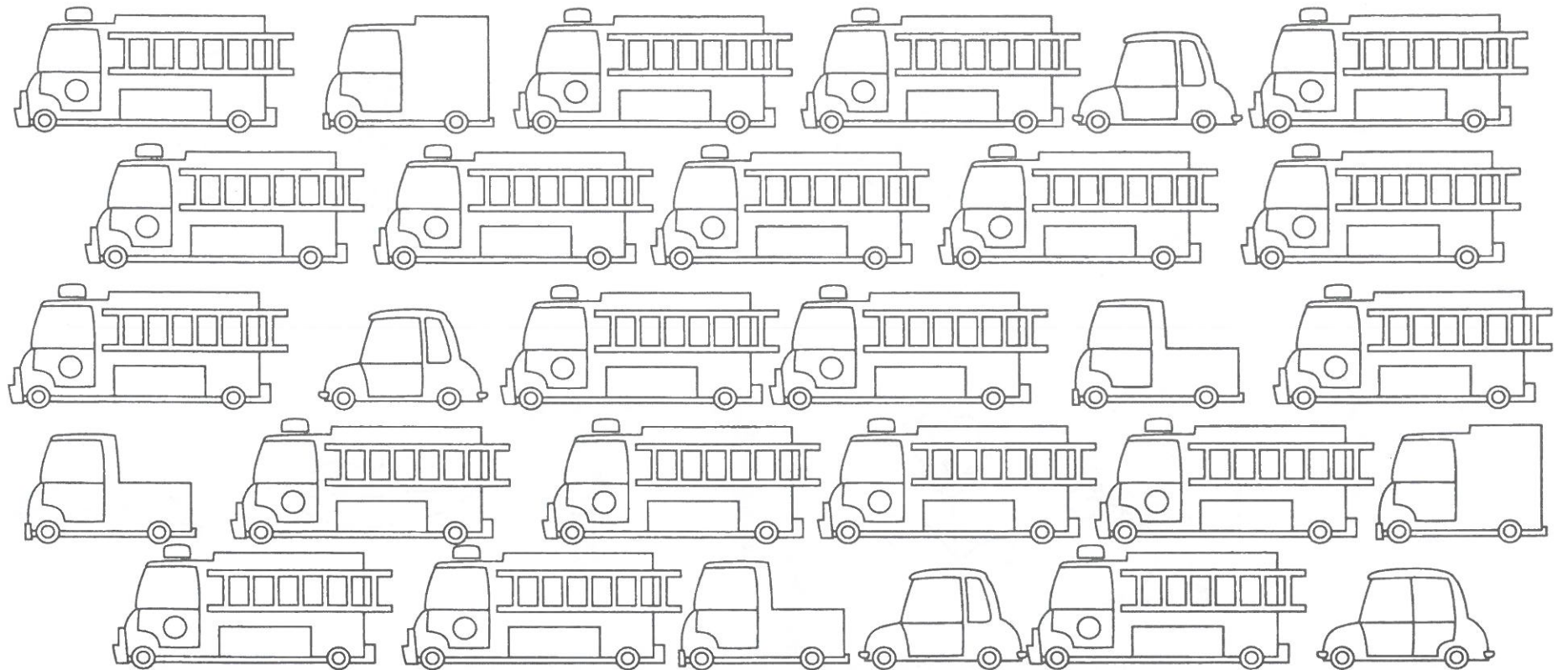

1 2 \_ 4 5 \_ 7 8 \_ 10  
11 12 13 \_ 15 16 \_ 18 \_ 20

Trace. Circle the items that begin with /f/.

Ff

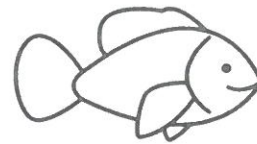

Ff

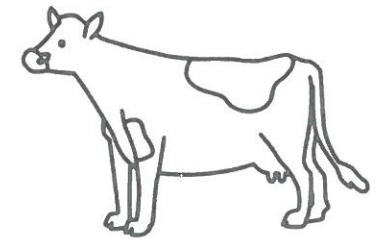

Ff

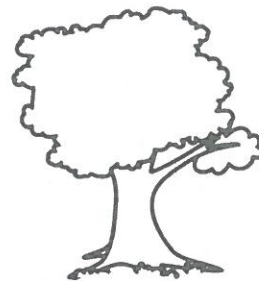

Ff



Ff

5

9

Ff





Look and listen. Draw an arrow to the next picture.

# Shopping with Mommy

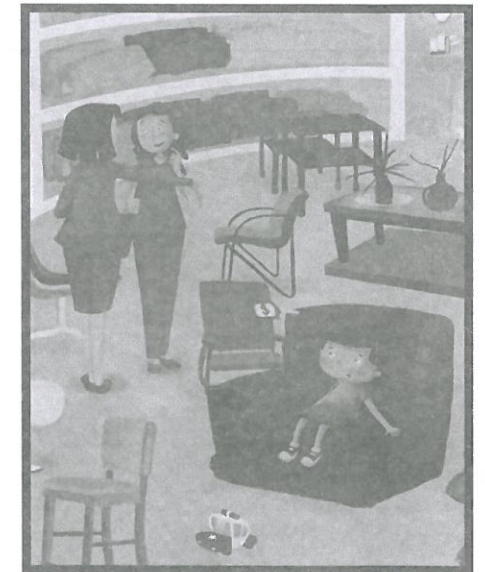



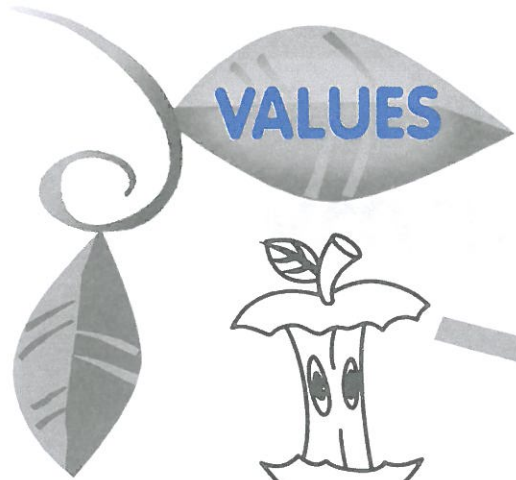

VALUES

Look and match.

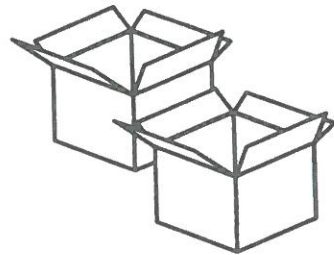
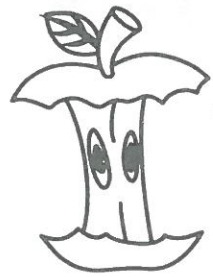
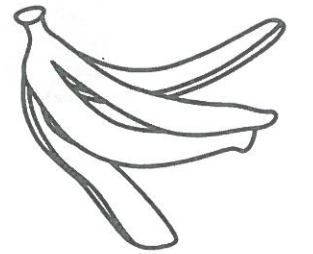
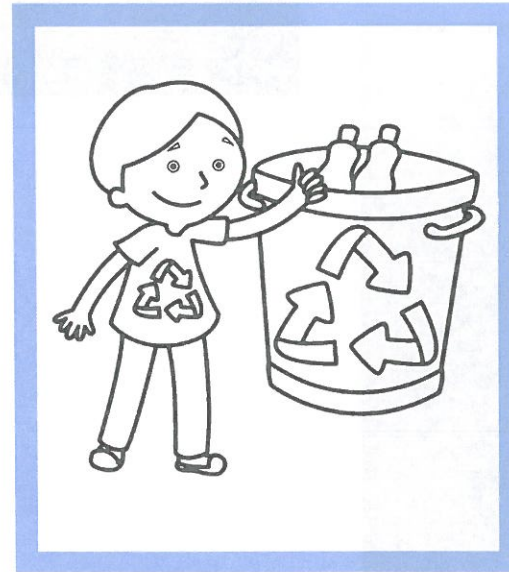
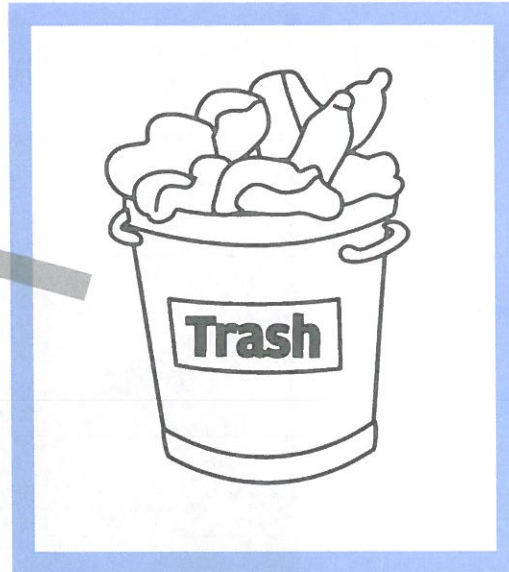

Trace the moons. Draw a moon in the sky and color.

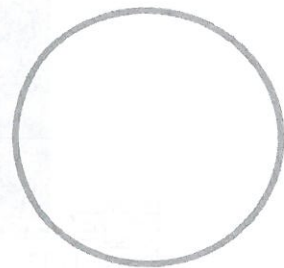
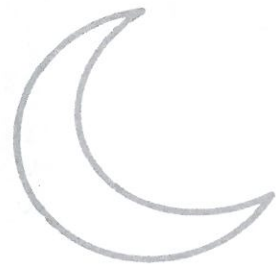

Amazing: Science Connection: crescent moon, half moon, full moon, telescope

# MY WORLD

Draw your favorite place.

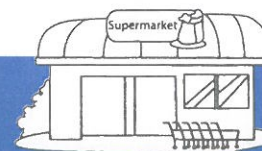
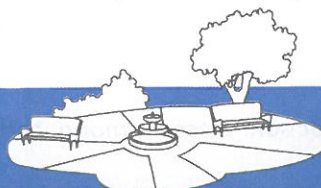

# 9

# SHOW TIME!

Look and review.

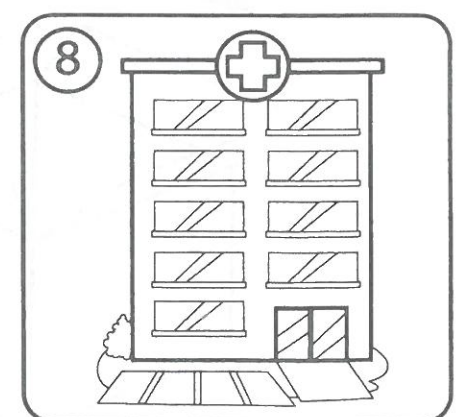
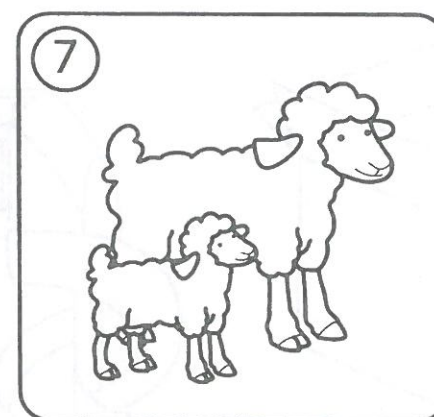
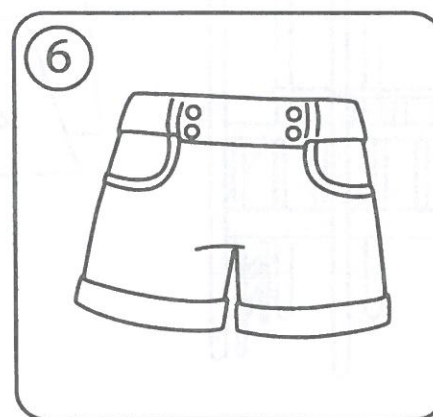
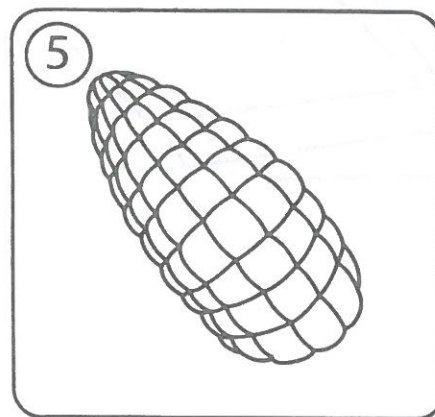
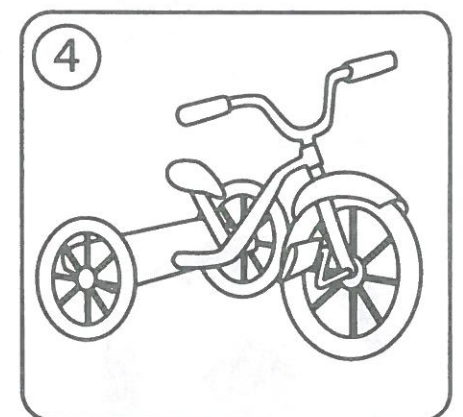
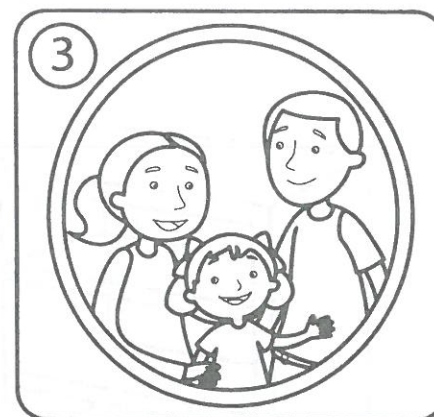
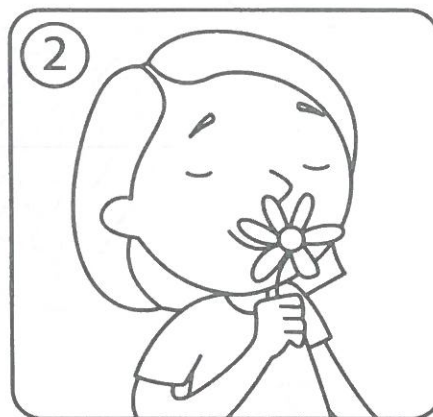
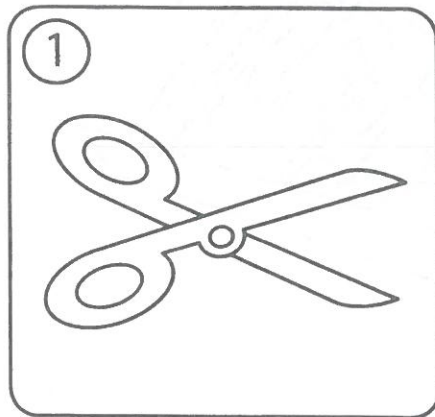

Review Units 1–8: scissors, nose/smell, aunt/uncle/cousin, tricycle, corn, shorts, lamb/sheep, hospital

**Unit 1: Look and say. Color the objects you use inside a classroom.**

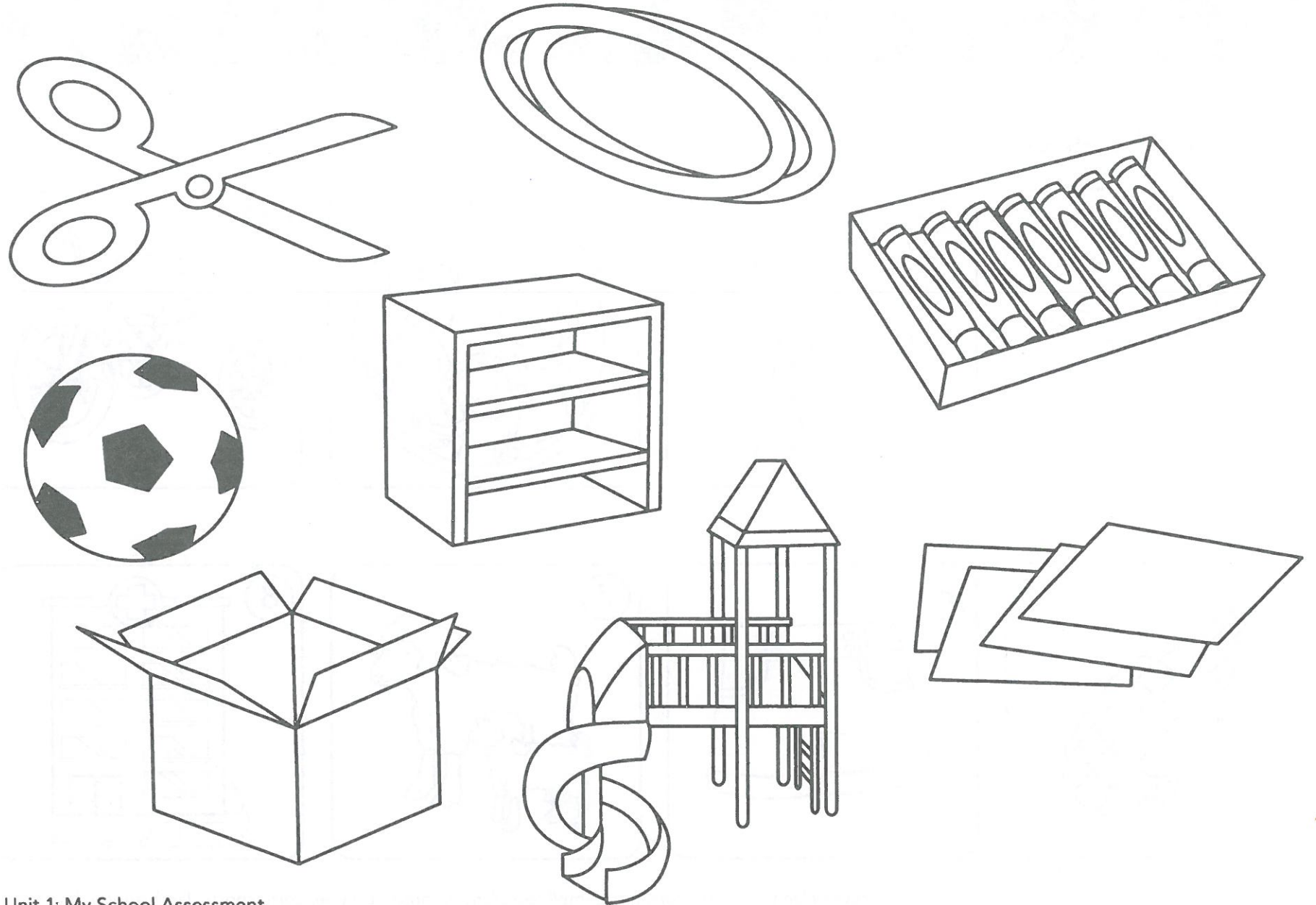

**Unit 2: Look and match what you hear, smell, and taste.**

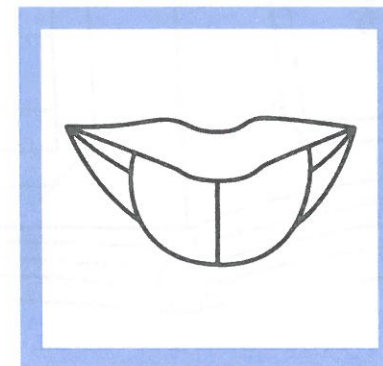
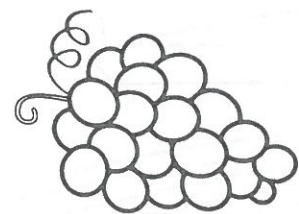
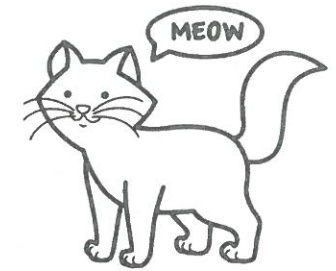
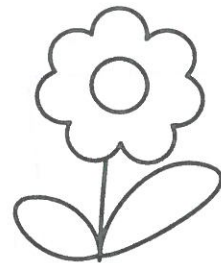
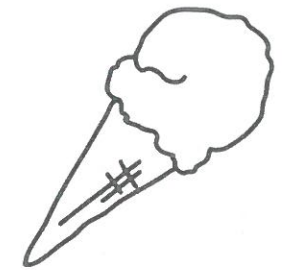
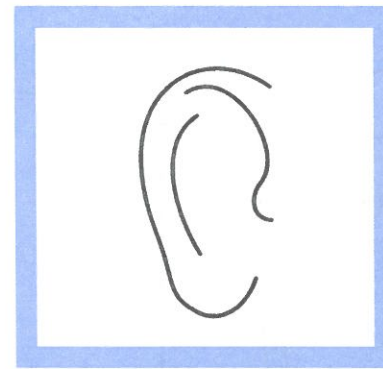
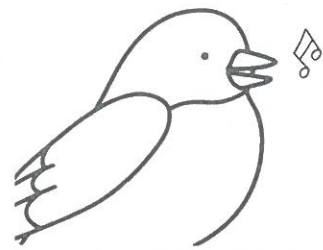

**Unit 3: Name the family members and pets.  
Circle the type of home you live in.**

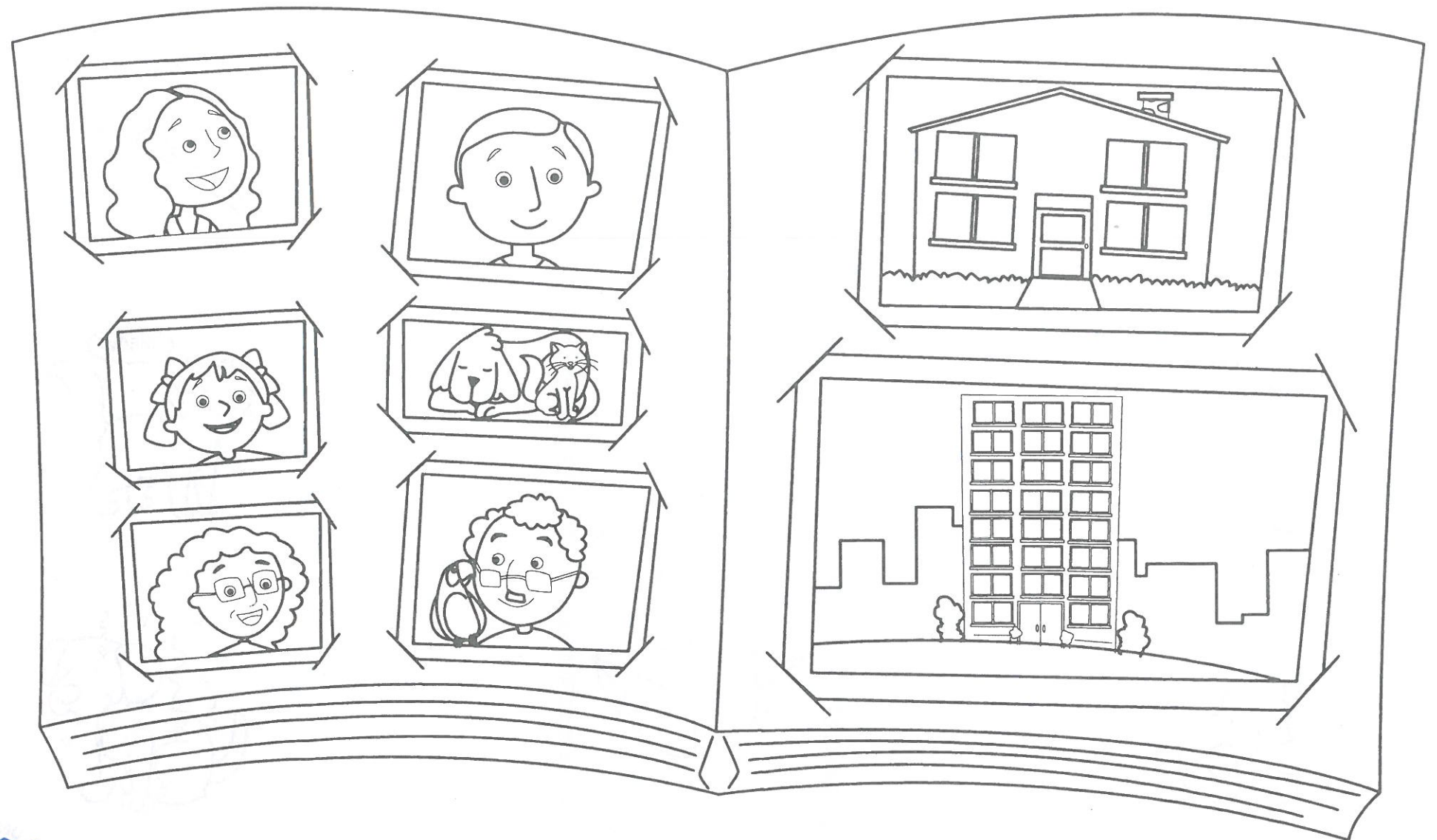

**Unit 4: What toys do you have? Look and circle.**

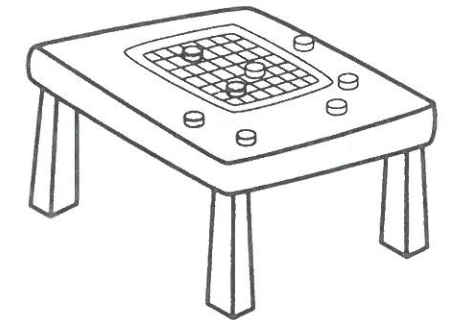
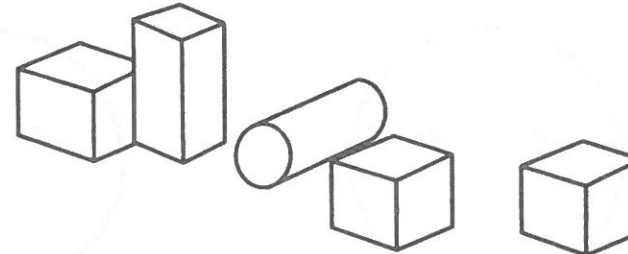
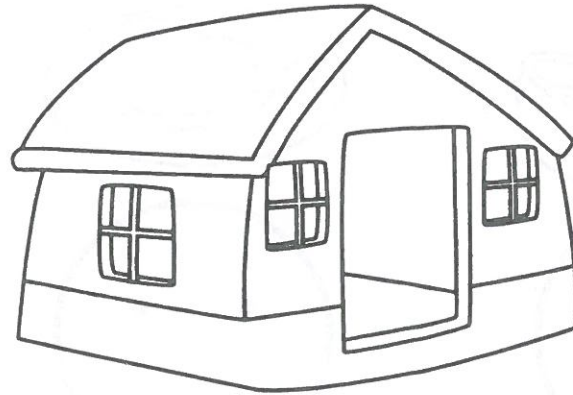
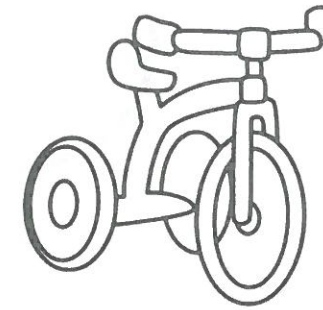
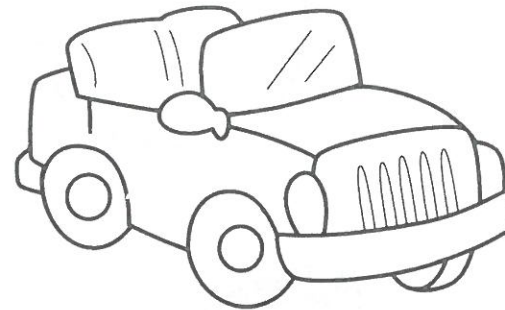
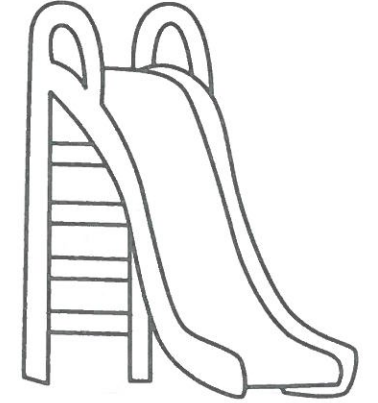



Unit 5: What do you like? Look and complete the faces.

 I like...

 I don't like...

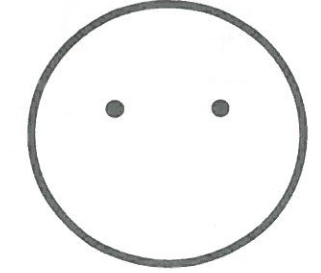
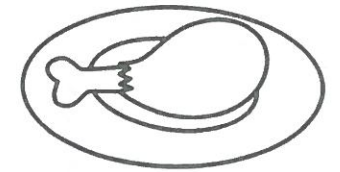
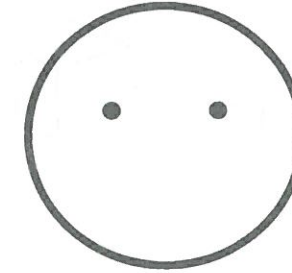
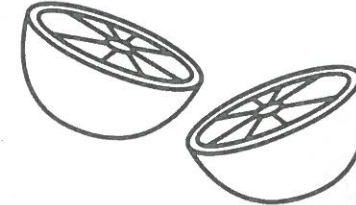
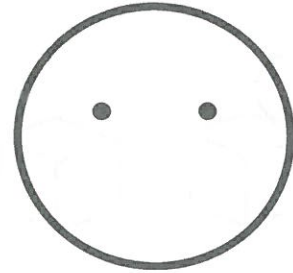
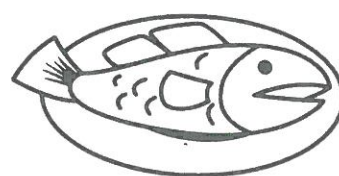
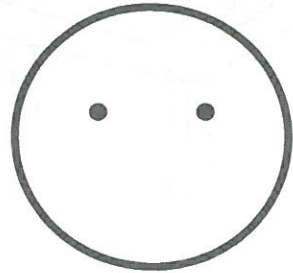
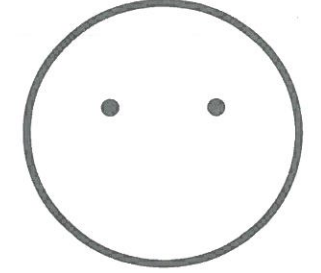
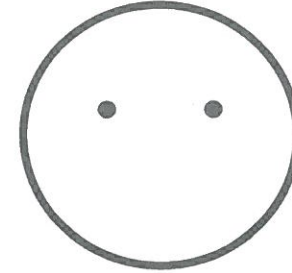
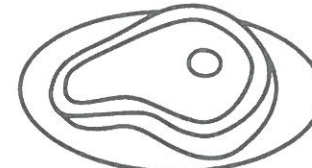
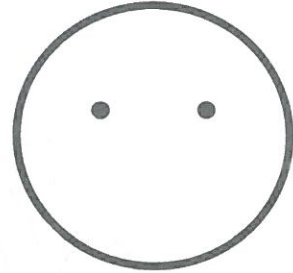
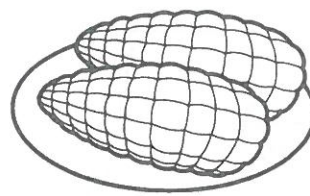
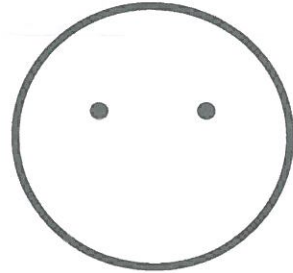
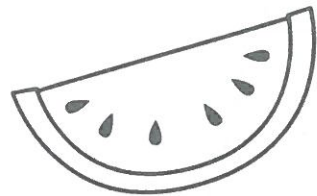

**Unit 6: What is missing? Look and match.**

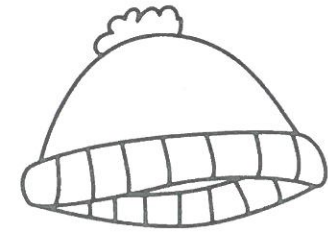
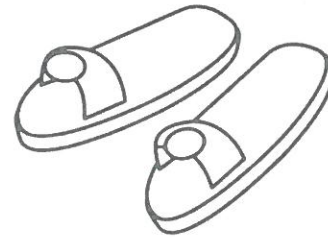

**Unit 7: Where are the animals? Look and say.**

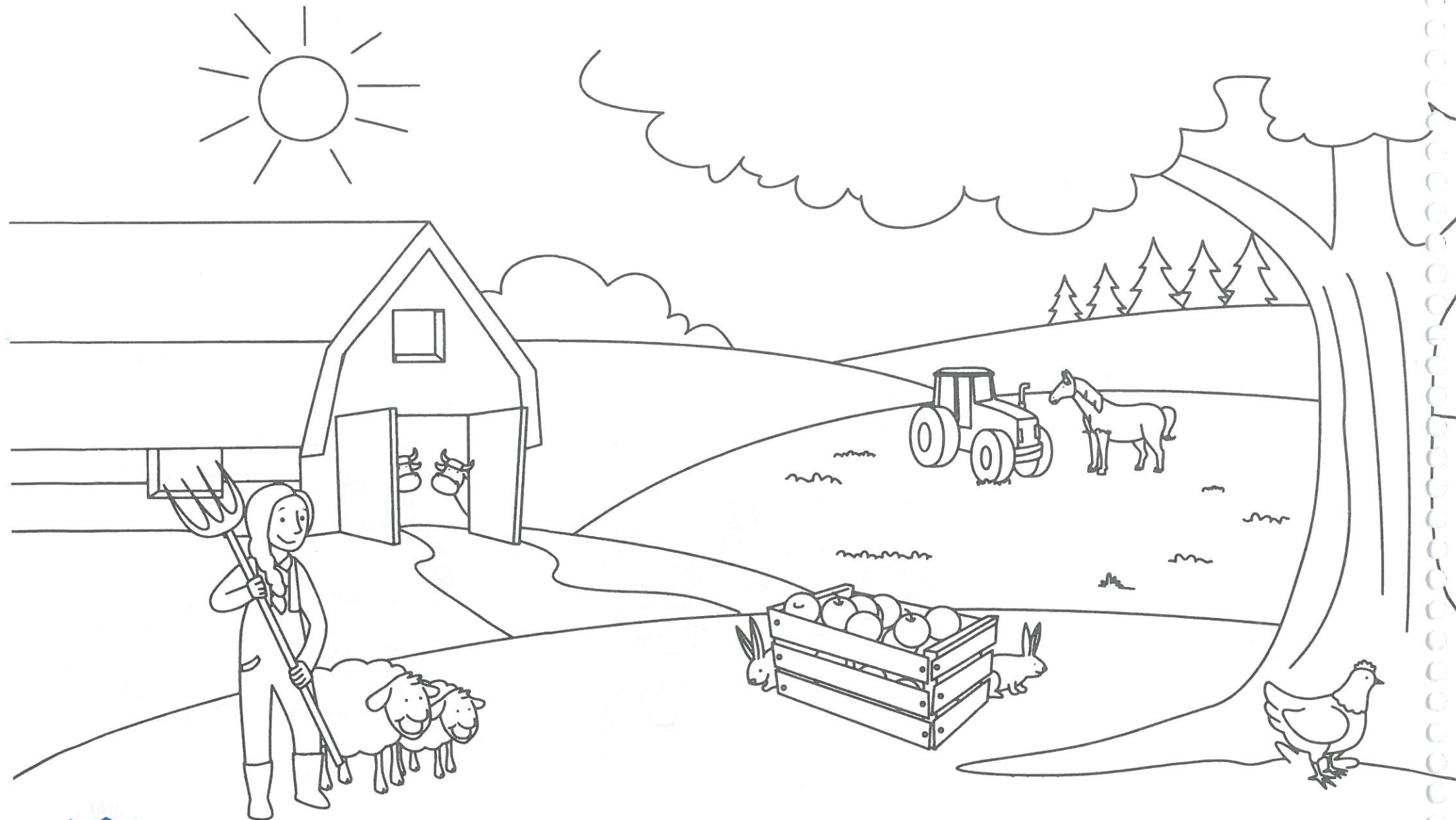

**Unit 8: Where is the...? Place a marker and say.**

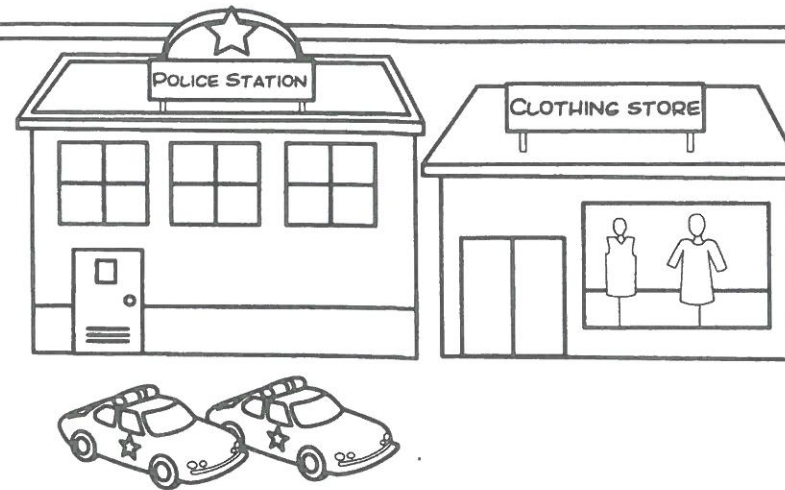
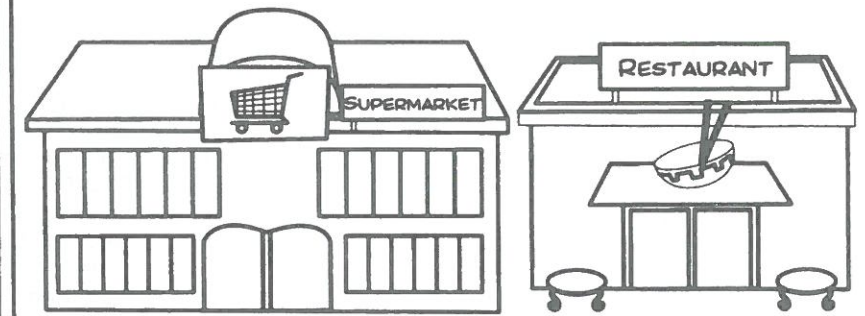
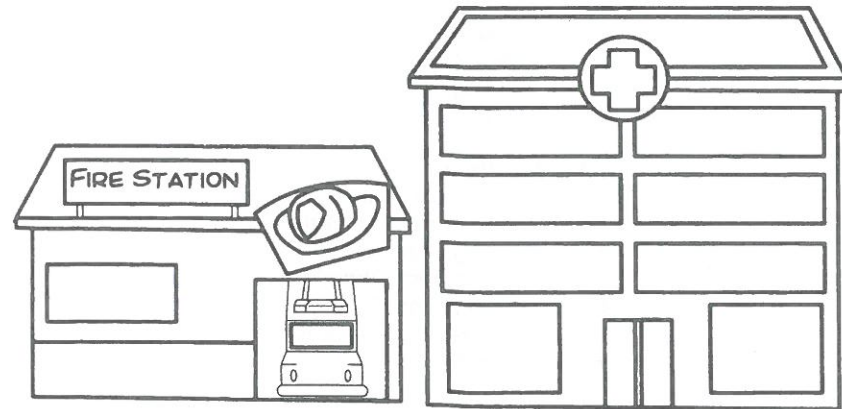

## Workbook Audio CD

### NEW BIG FUN WORKBOOK 2 Audio CD

TRACK	ACTIVITY
1	Copyright information
2	"Big Fun Theme Song"

#### Little Books

3	Unit 1 <i>Draw and Color</i>
4	Unit 2 <i>Guessing Game</i>
5	Unit 3 <i>Show and Tell</i>
6	Unit 4 <i>Outdoor Fun</i>
7	Unit 5 <i>I Like Apples</i>
8	Unit 6 <i>How Many?</i>
9	Unit 7 <i>Where Are the Lambs?</i>
10	Unit 8 <i>Shopping with Mommy</i>

#### Songs and Chants

##### Unit 1: My School

11	"Hello Song"
12	"Stop, Look, and Listen Chant"
13	"Let's Have Fun"
14	"Good-bye Song"
15	Target Song "My School"
16	"Look at Me Chant"
17	"Numbers 1, 2, 3 Chant"
18	"We Have Finished Chant"
19	"Amazing Snails Chant"

##### Unit 2: My Senses

20	Target Song "Senses"
21	"My Crayon Box"
22	"Numbers 4, 5, 6 Chant"
23	"Letter Sounds (S)"
24	"Taking Turns Chant"
25	"Amazing Tongues"

##### Unit 3: My Family

26	Target Song "My Family"
27	"People We Know"
28	"Numbers 7, 8, 9 Chant"
29	"Letter Sounds (M and F)"
30	"Grandma Gave Me Cookies"

##### Unit 4: My Toys

31	"Days of the Week"
32	"Actions Song"
33	Target Song "My Toys"
34	"Writing Numbers 10, 11, 12"
35	"Animals Talk"
36	"Sometimes"
37	"Amazing Clouds"

##### Unit 5: Food

38	Target Song "Food"
39	"Writing Numbers 13, 14, 15"
40	"Letter S Song"
41	"Being Polite Song"

##### Unit 6: My Clothes

42	Target Song "My Clothes"
43	"Put It On Chant"
44	"Writing Numbers 16, 17"
45	"Letter M Song"

##### Unit 7: Animals

46	Target Song "The Farm"
47	"This and That Song"
48	"Writing Numbers 18, 19"
49	"Letter L Song"

##### Unit 8: My World

50	"It's a Week Chant"
51	Target Song "My World"
52	"Writing Number 20"
53	"Prepositions Chant"
54	"Letter F Song"
55	"Shapes and Colors Song"
56	"Night Sky"

##### Unit 9: Show Time!

57	"Show Time"
----	-------------

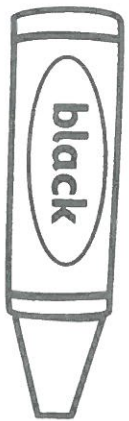

has finished *New Big Fun Workbook 2!*

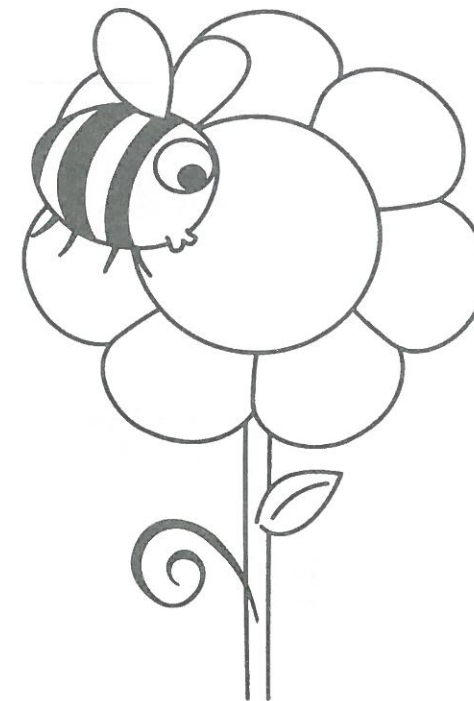





موسسه زبان دهخدا  
dehkhodaedu.com



# NEW BIG FUN

2

## WORKBOOK

Share in your students' success.  
Watch them enjoy learning  
English and new skills.

**New Big Fun** prepares students for a natural  
and positive experience with language:

- **Communication:** because young children like to express their interests and ideas
- **CLIL:** because young children are learning English and so much more
- **21st Century Skills:** because young children need to be prepared for the world that awaits them
- **Assessment for Learning:** because awareness and confidence lead to success.



ISBN 978-1-292-26574-2



9 781292 265742 >

Visit us at [www.english.com/bigfun](http://www.english.com/bigfun)  
dehkhodaedu.com