

NEW BIG

1

FUN

Workbook

Mario Herrera
Barbara Hojel

 Pearson





NEW
BIG
FUN
WORKBOOK



Mario Herrera
Barbara Hojel

**New Big Fun
Workbook 1 with Audio CD
Pearson Education Limited**

KAO Two, KAO Park, Hockham Way, Harlow, CM17 9SR, England and Associated Companies throughout the world.
www.English.com
© Pearson Education Limited 2018

Authorized Adaptation from the U.S. edition, entitled Big Fun, 1st Edition, by Mario Herrera and Barbara Hojel, published by Pearson Education Inc, © 2014 by Pearson Education, Inc.
The right of Mario Herrera and Barbara Hojel to be identified as authors of this Work has been asserted by them in accordance with the Copyright, Designs and Patents Act 1988.
All rights reserved; no part of this publication may be reproduced, stored in a retrieval system, or transmitted in any form or by any means, electronic, mechanical, photocopying, recording, or otherwise without the prior written permission of the Publishers

First published 2018

ISBN: 978-1-292-26573-5

Set in Gill Sans Infant Std, Avenir LT Pro, ITC Avant Garde Gothic Std, Banco ITC Font

Printed in China (SWTC/02)

Text composition: TSI Graphics

Illustration credits: A Corazón Abierto, Francisco Morales, Luis Alberto Montiel Villegas, Javier Montiel

PEARSON ELT ON THE WEB

PearsonELT.com offers a wide range of classroom resources and professional development materials. Access course-specific websites, product information, and Pearson offices around the world.

Visit us at www.pearsonELT.com.



CONTENTS

1 My Class.....	1	6 My Clothes	51
2 My Body	11	7 Animals.....	61
3 My Family	21	8 My World	71
4 My Toys	31	9 Show Time!	81
5 My Lunch.....	41		



NEW **BIG FUN** Song

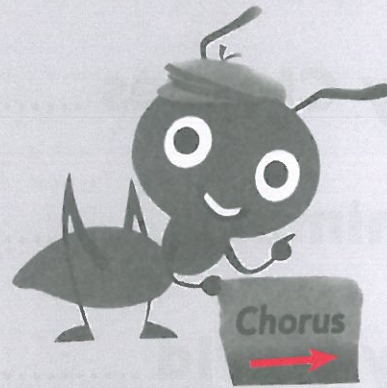
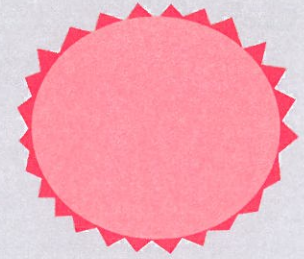

*From the sky to the ground
And all the way around—
We can have big fun!
If there's rain, if there's sun,
Let's play with everyone.
We can have big, big fun!*



**Take a walk outside.
Our world is big and wide.
There are flowers and trees
And yellow bumblebees.
Buzz, buzz, buzz!**

(Chorus)

**Join your hands with me.
Let's see what we can see!
Then take a closer look.
We'll learn beyond our book.
Look, oh, look!**

(Chorus)

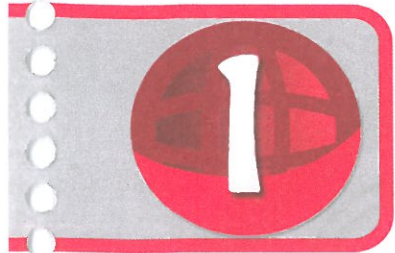

MY CLASS

Find the puppet. Color.

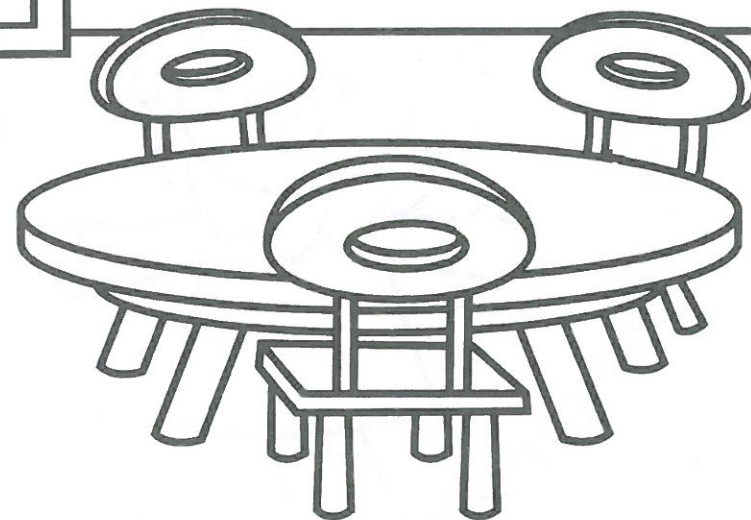
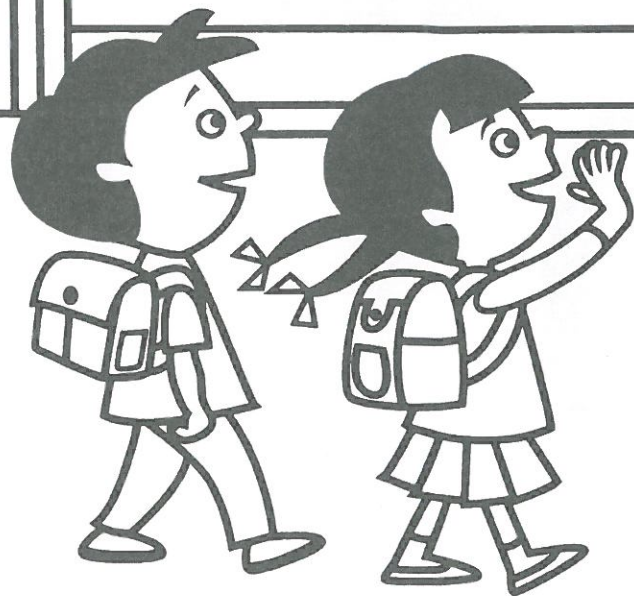
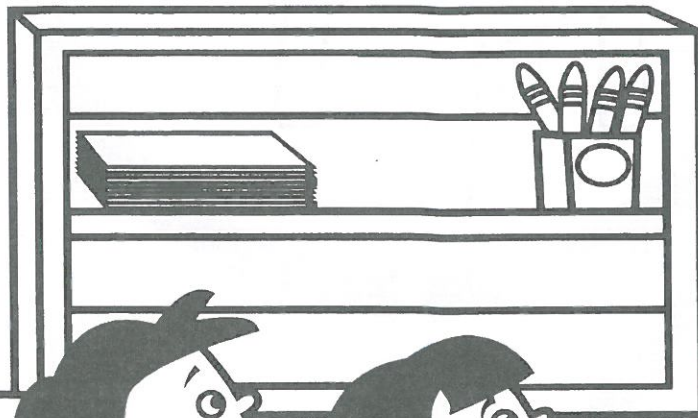

Trace and color.

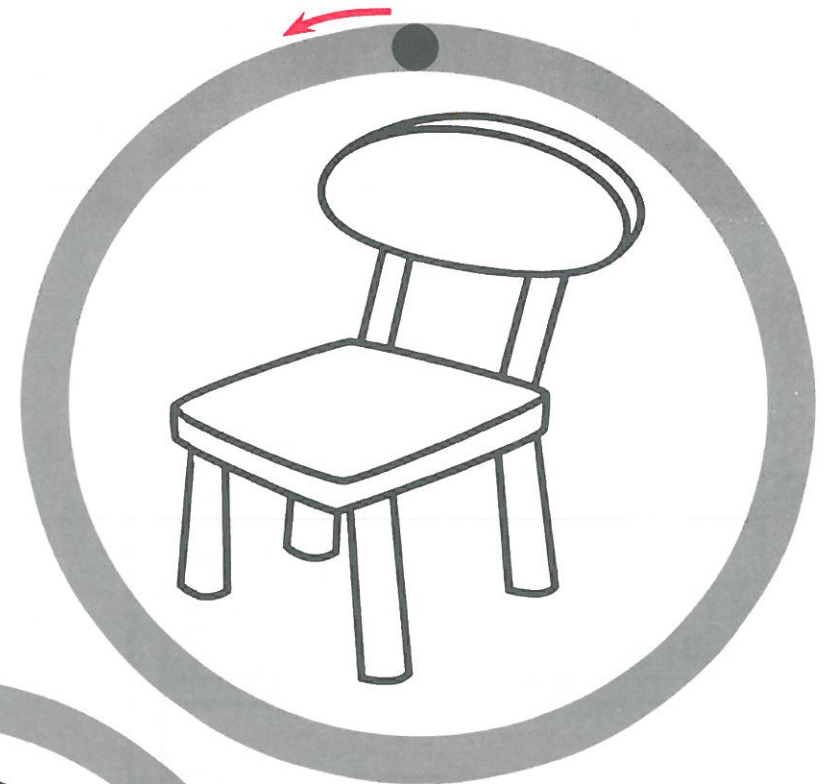
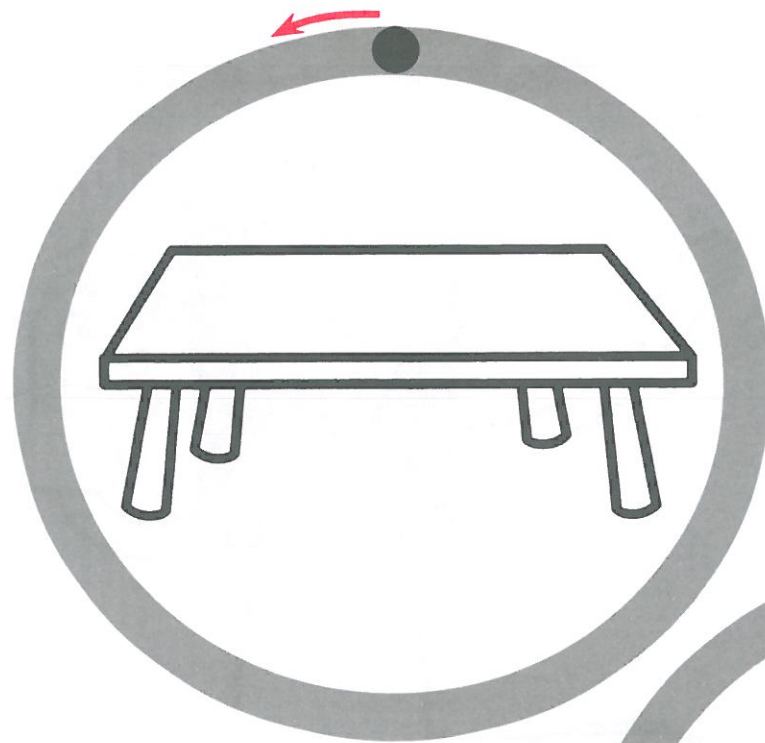

Match and color.

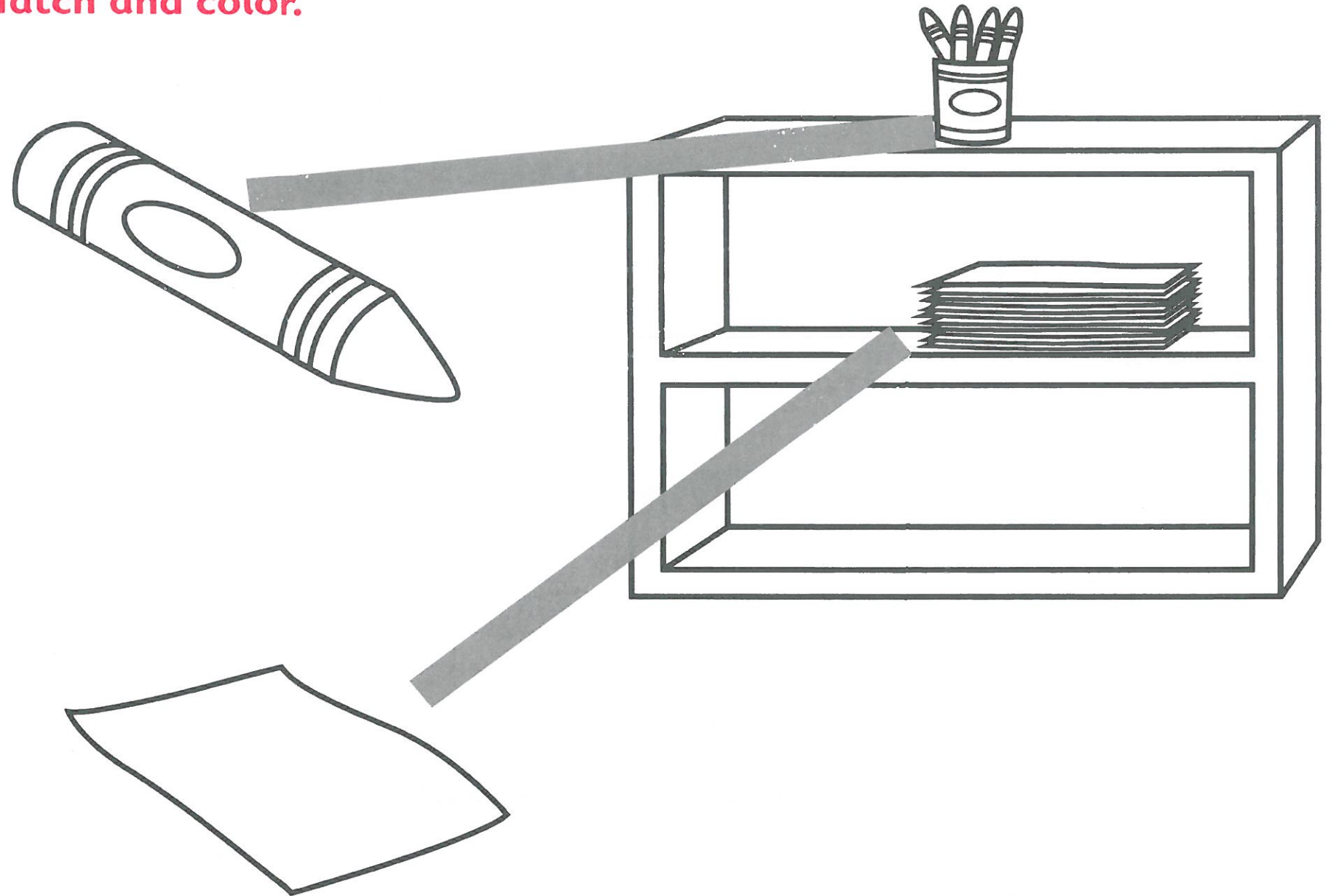

Look and match.

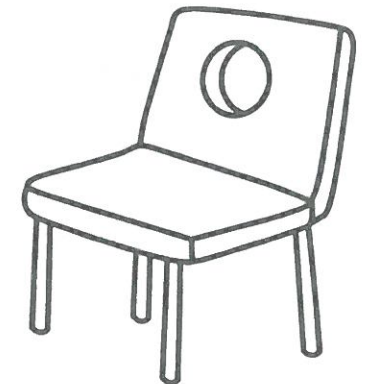
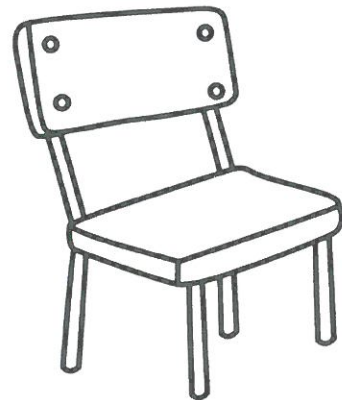
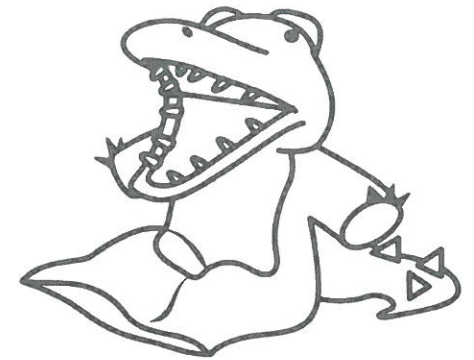
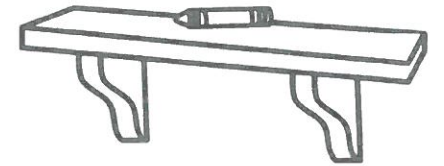
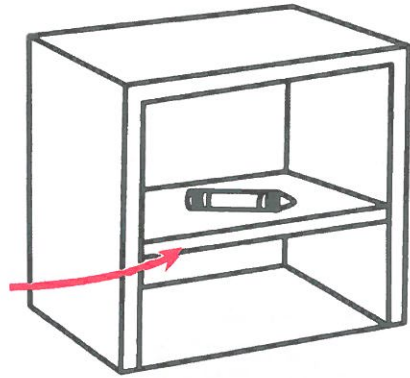

Trace and color.

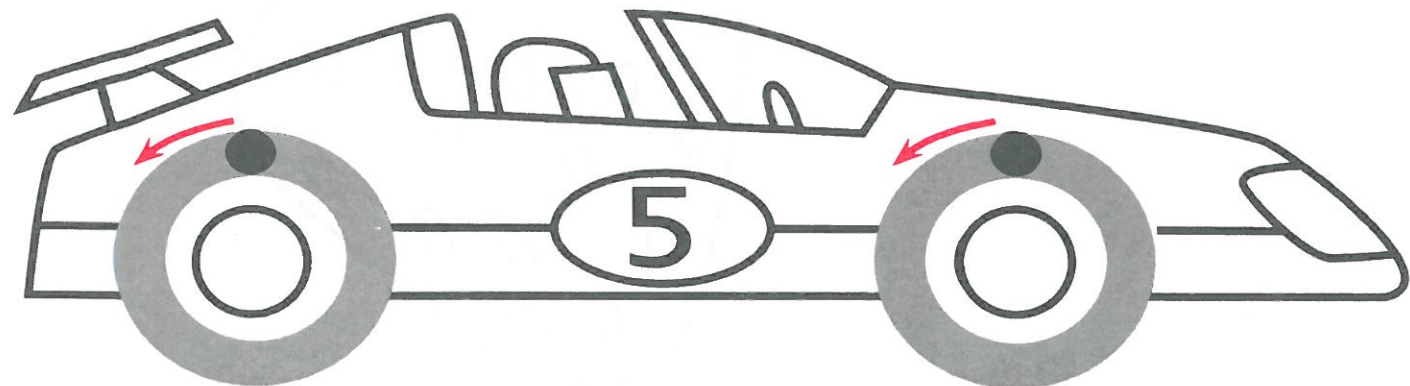
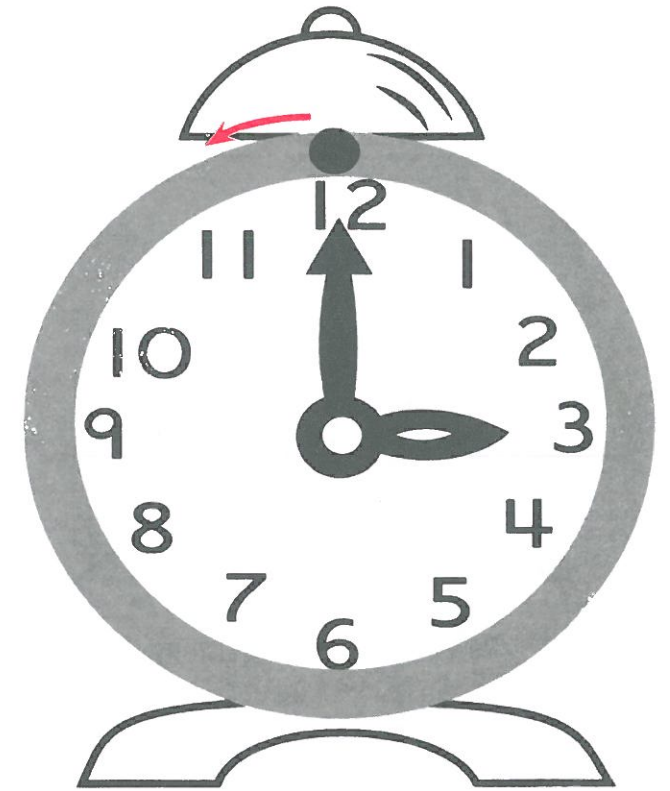
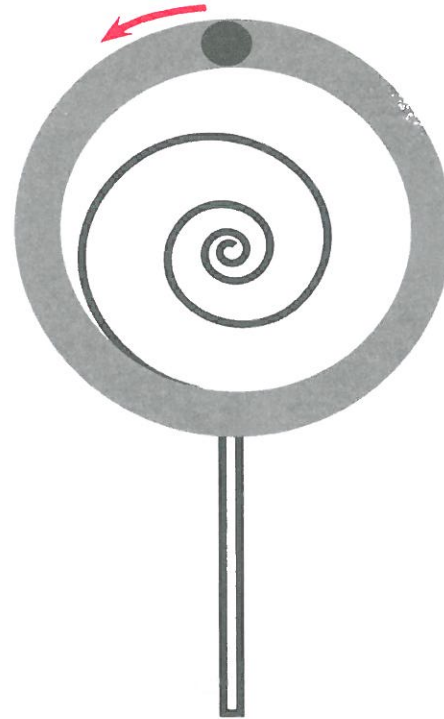
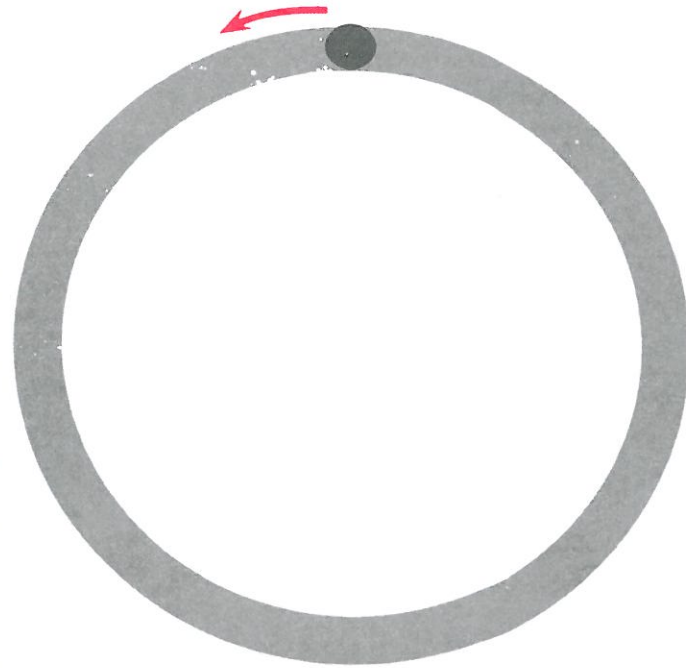

Color the crayon and paste red paper.

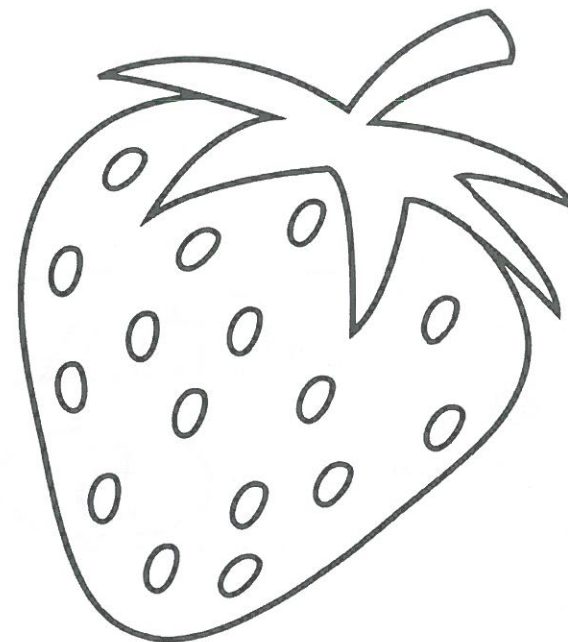
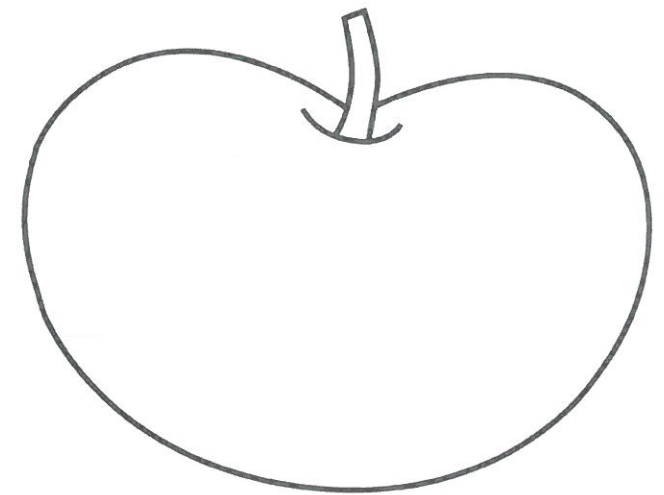
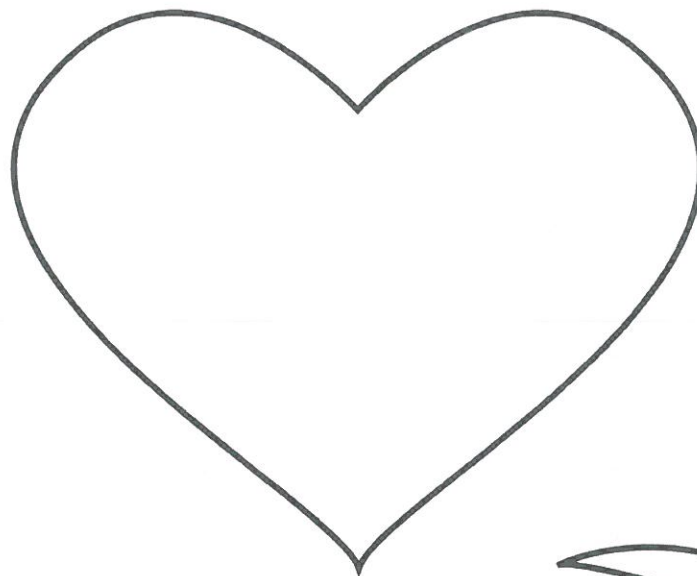
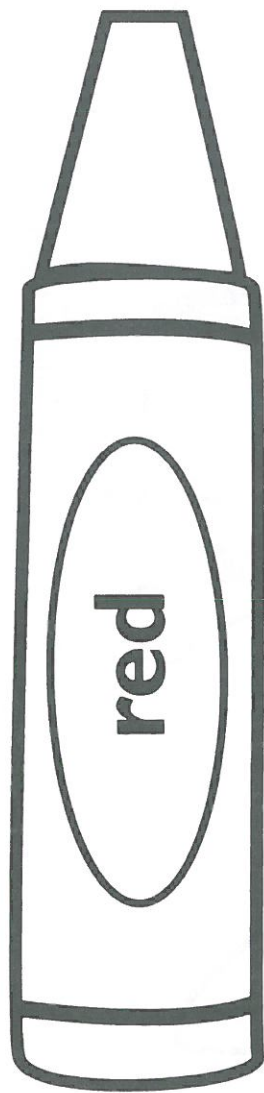



Look and listen. Trace.

School Days

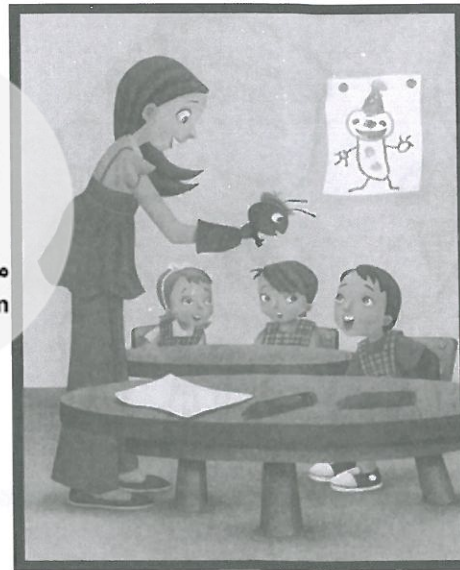
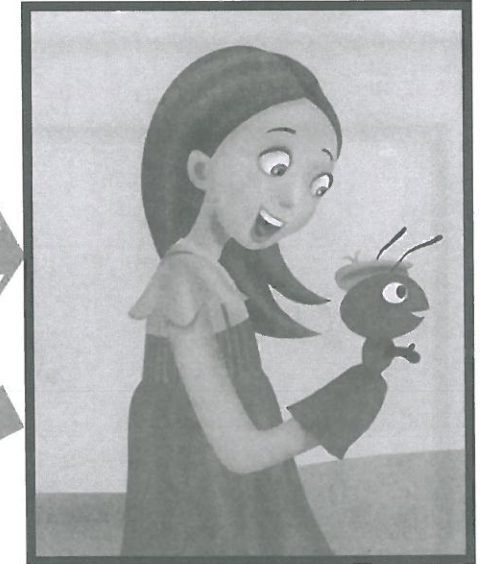

دهخدا

موسسه زبان دهخدا
dekhodaedu.com

Story Sequence: School Days

VALUES

Who is working together? Color the frame.



Find the bugs. Trace and color.

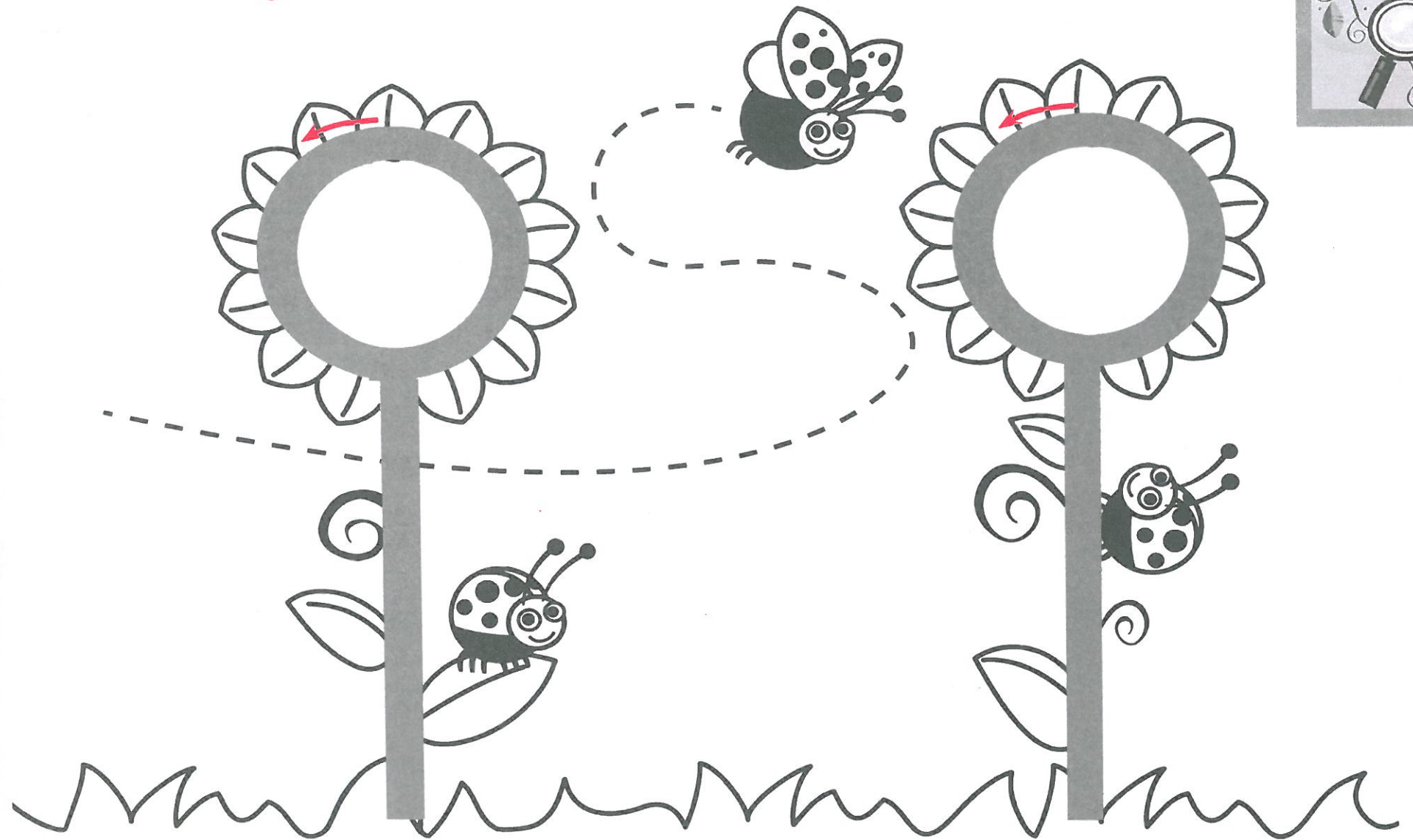

MY CLASS

Color the circles. Draw something from your classroom.

2

MY BODY

Find the mouth, nose, and eyes. Color.



Trace and color.

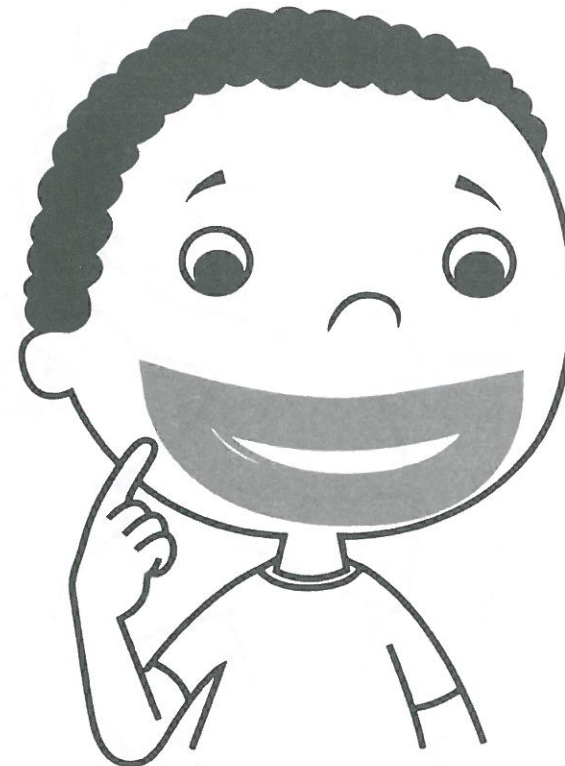
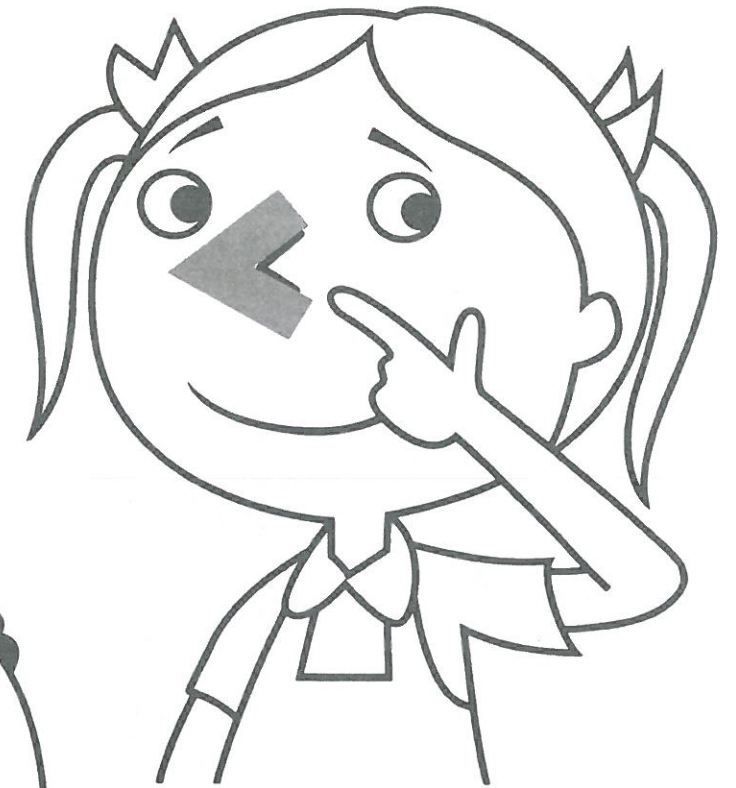
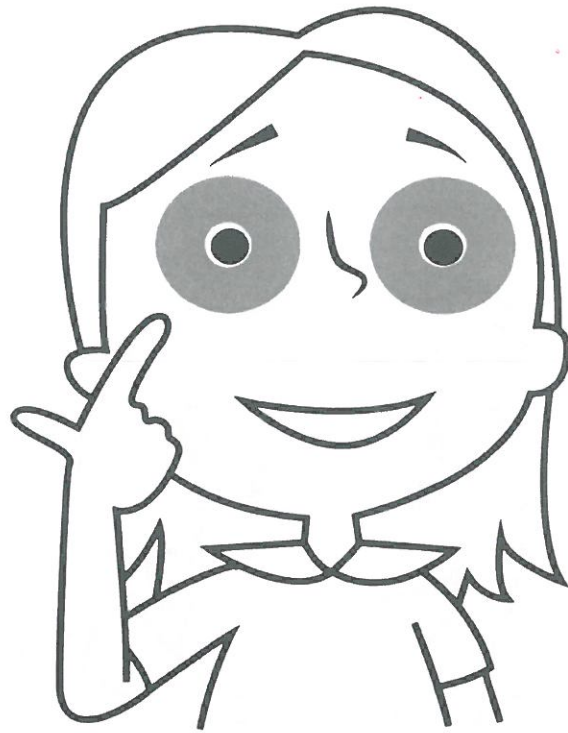

Look and draw the boy's missing parts.

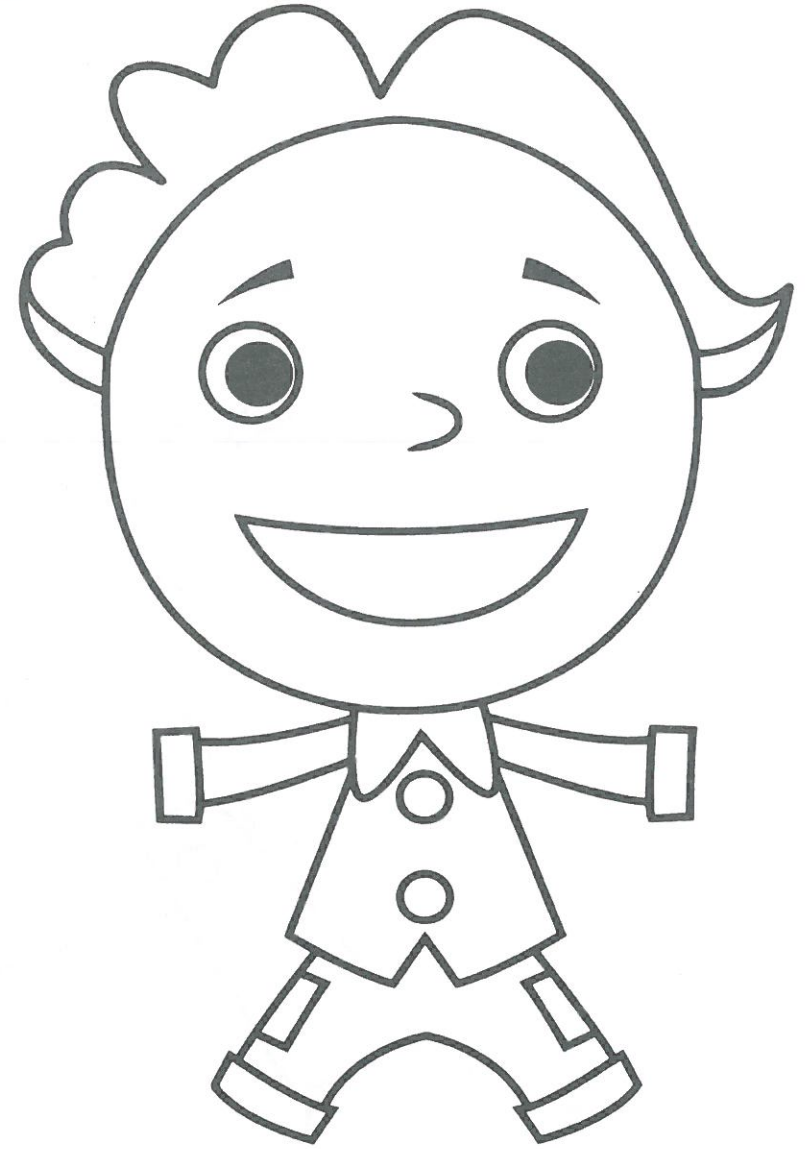
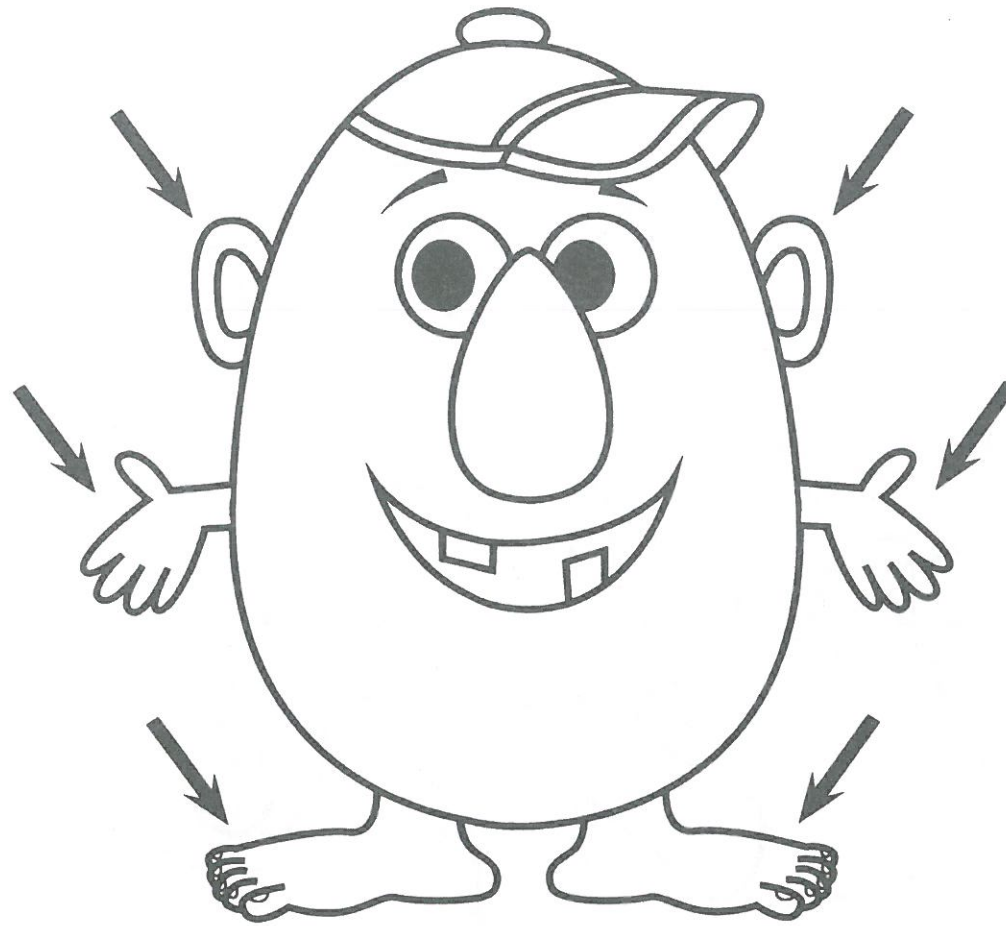

Color the mouth, hands, and feet.



Trace and color.

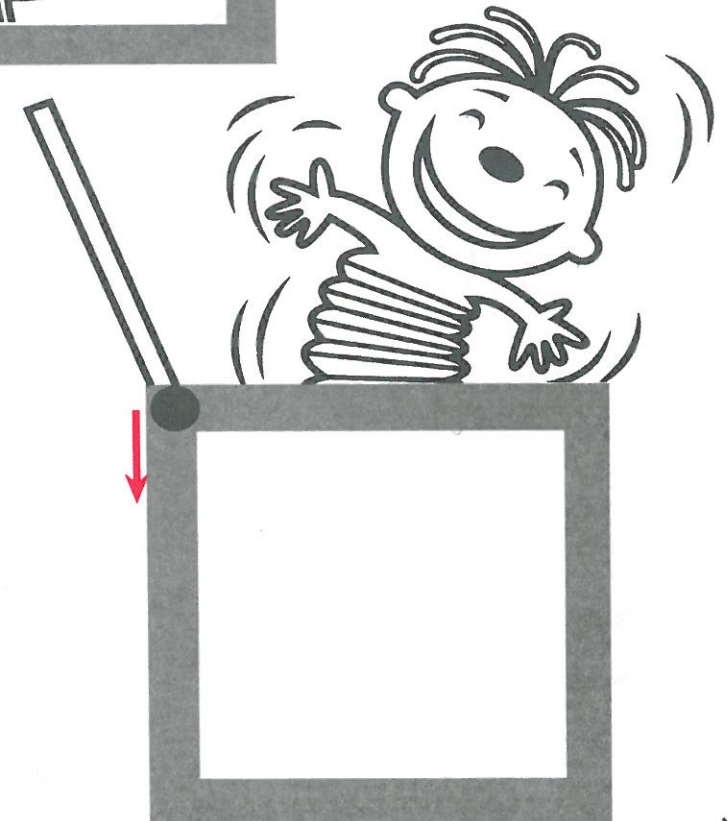
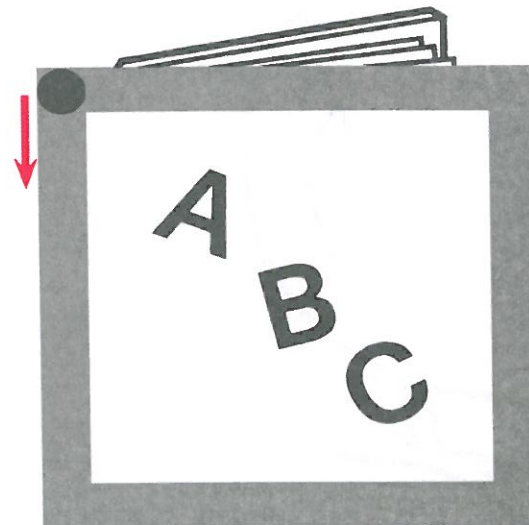
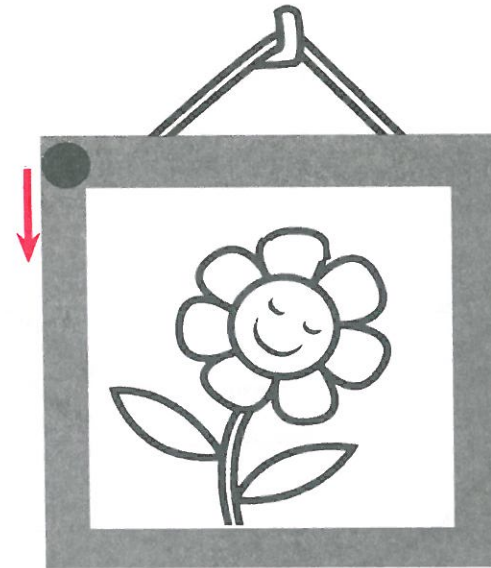
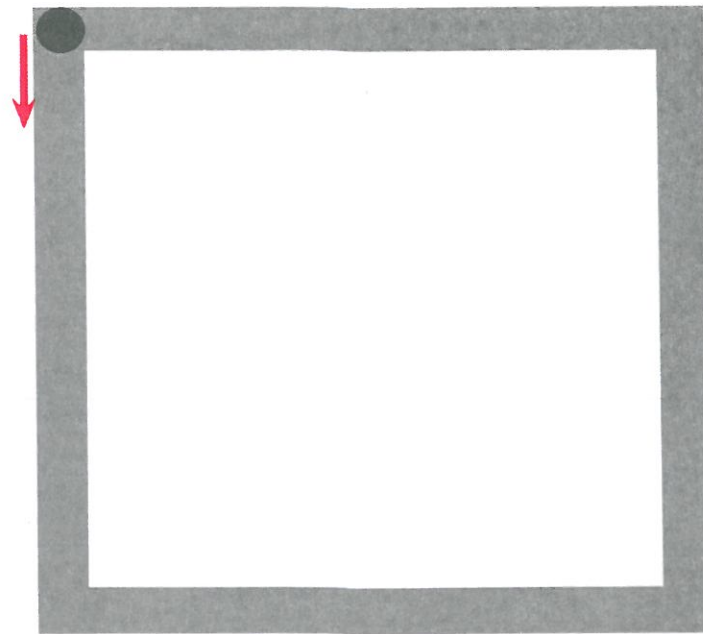

Color and draw something yellow.

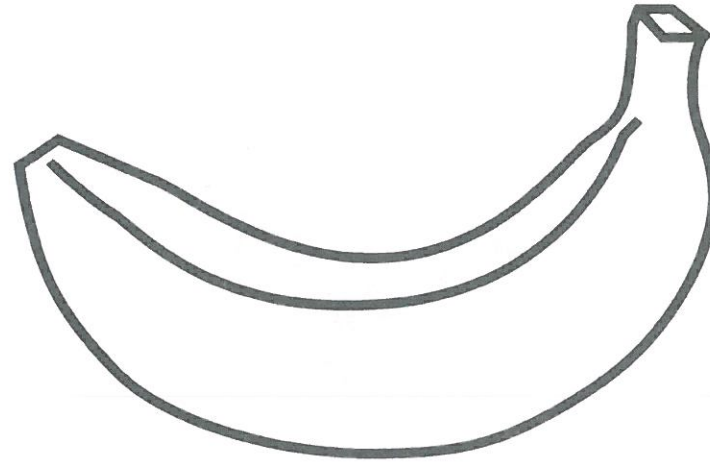
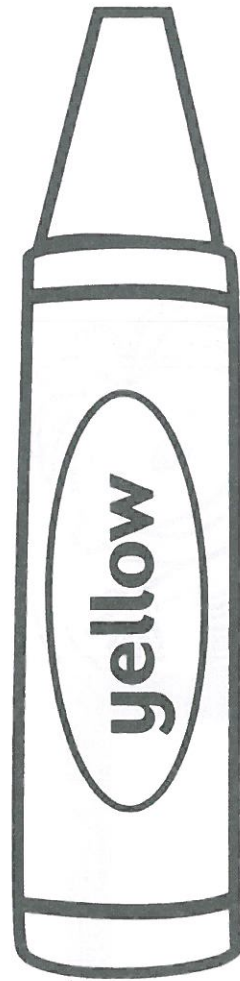



Look and listen. Trace.

What Is This?

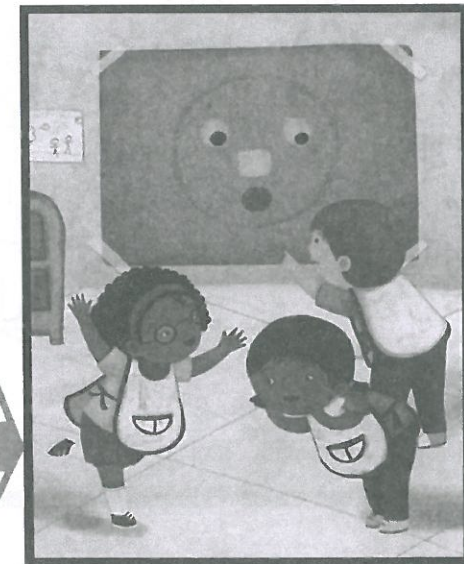
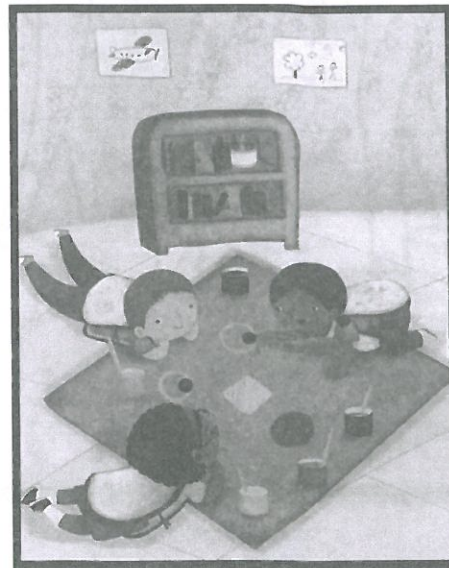

Story Sequence: What Is This?

VALUES

Who is greeting others? Color the frame.

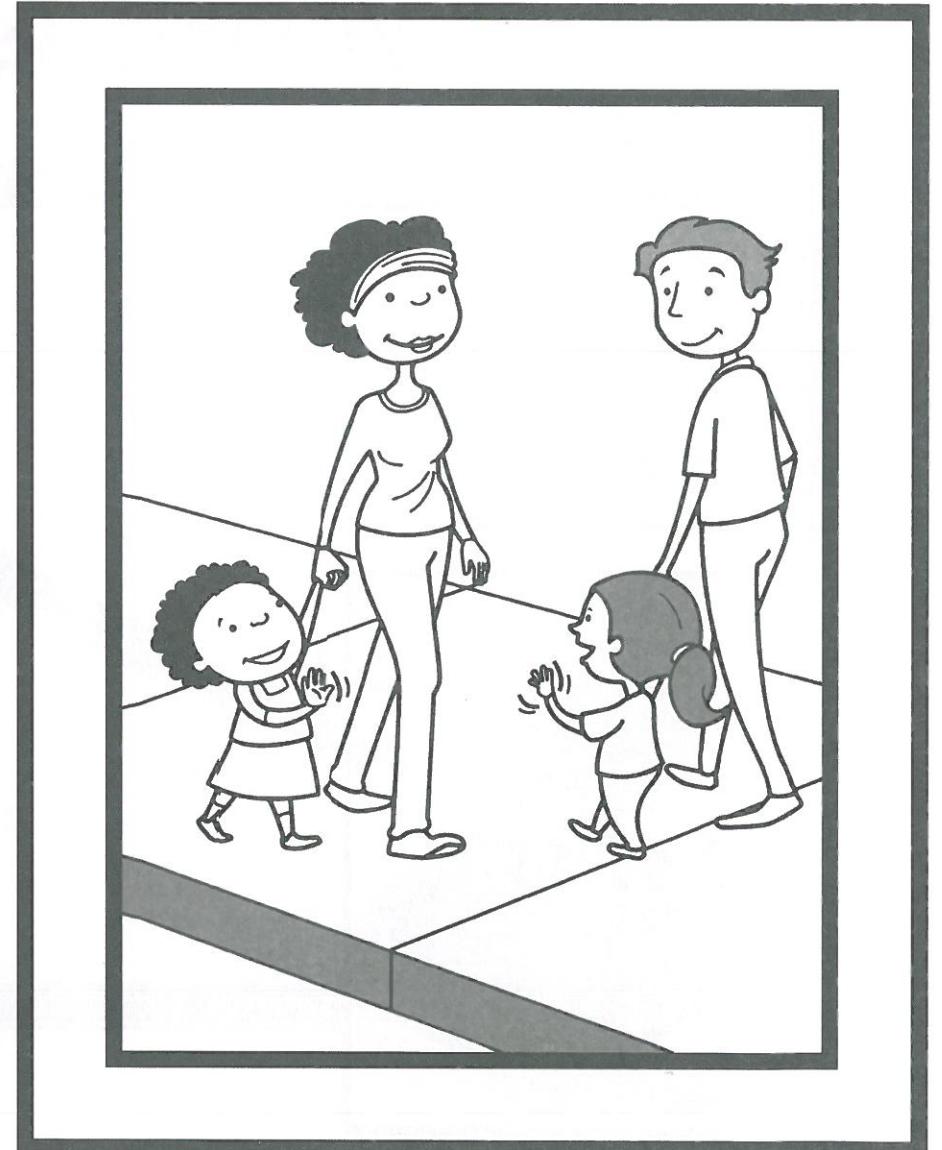

Trace the wings. Paste colored paper.

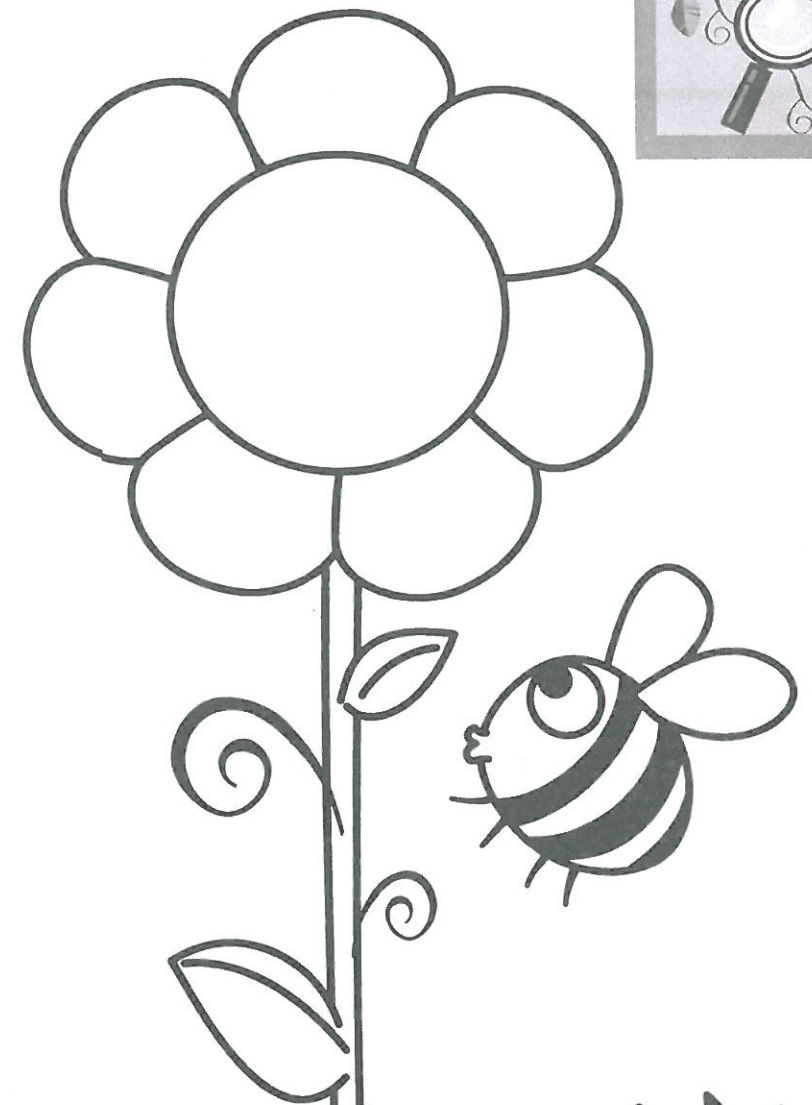
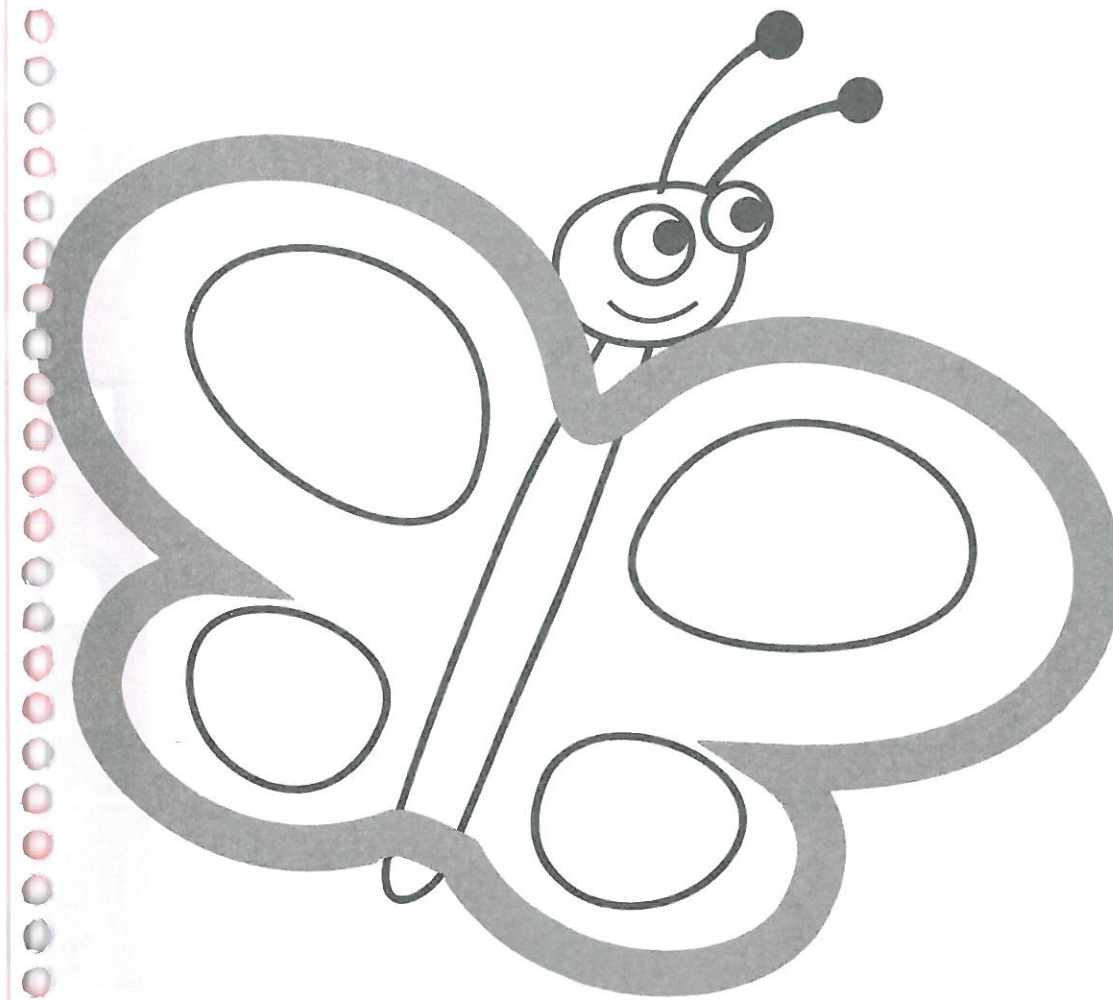

MY BODY

Color the squares. Draw yourself.

3

MY FAMILY

Find the brother. Color.

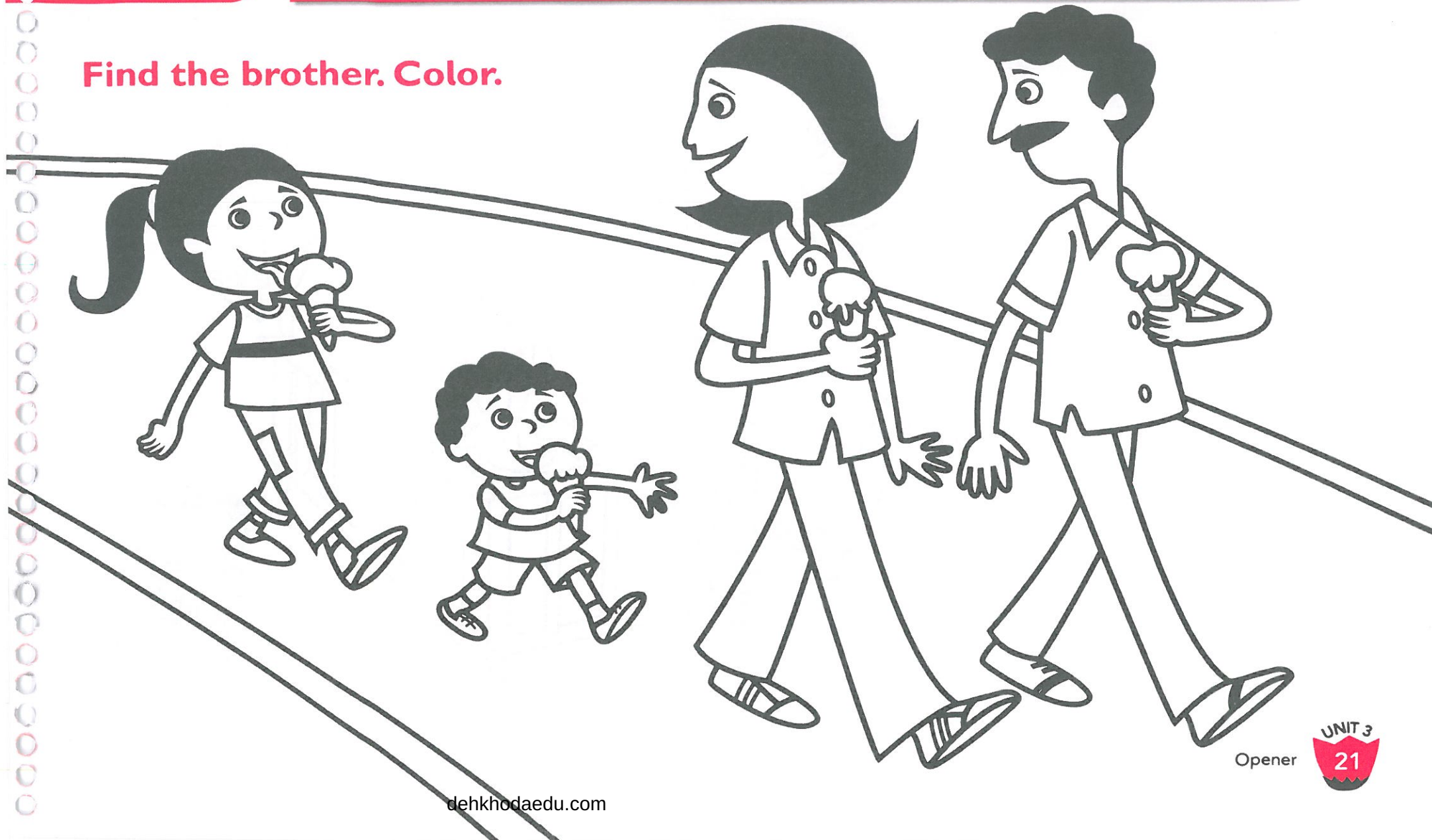

Trace and match.

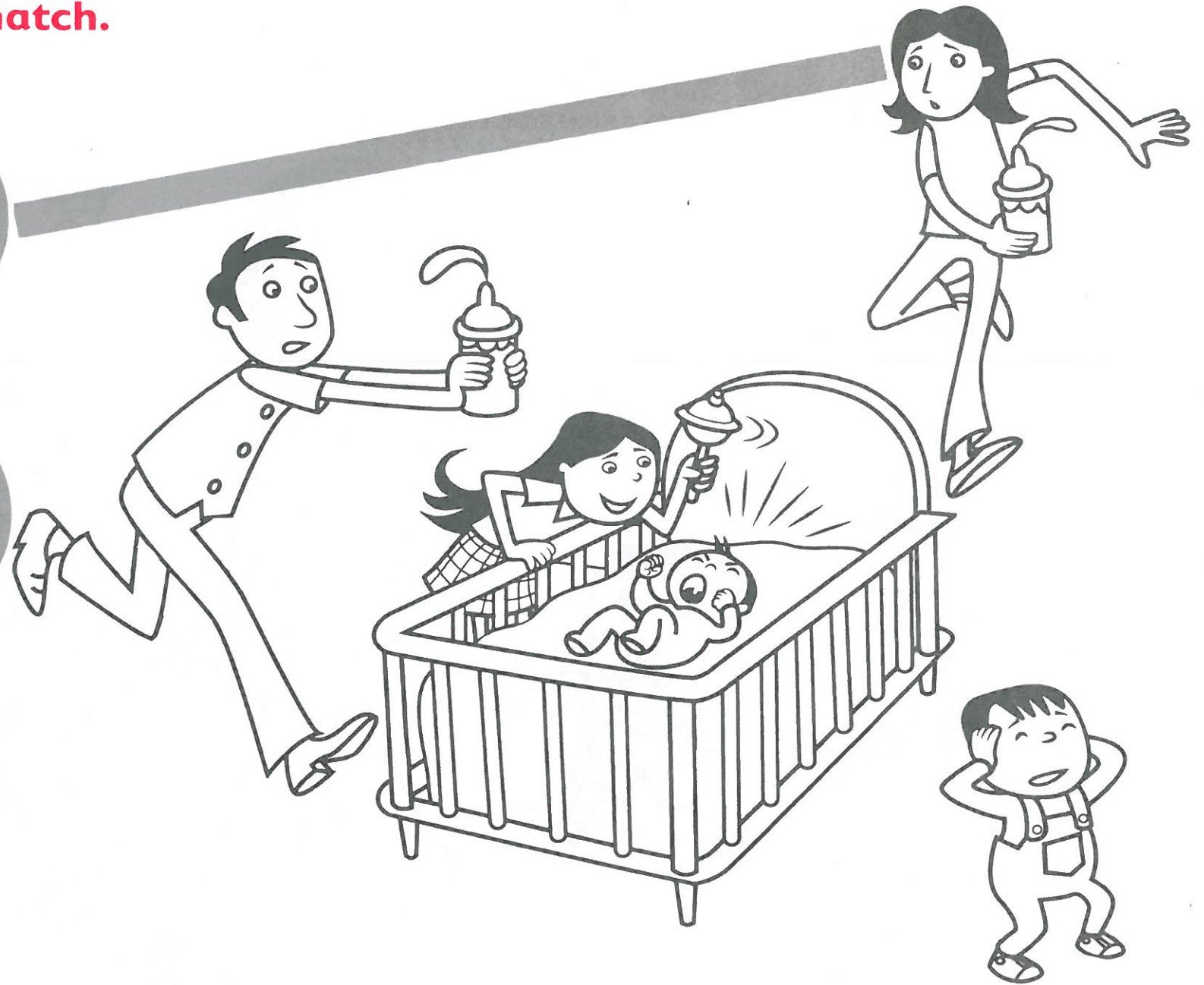

Look and match. Color the frames.

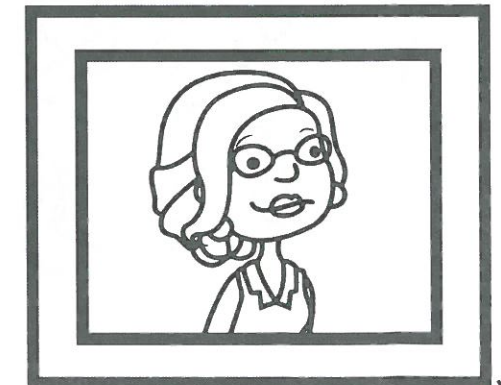
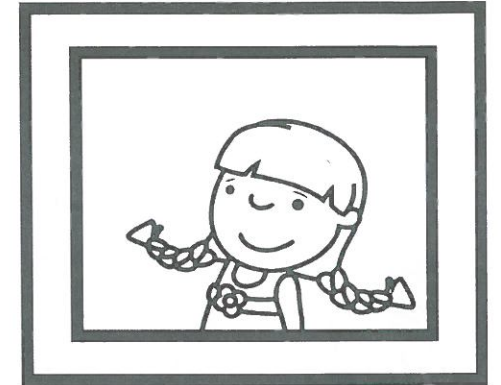
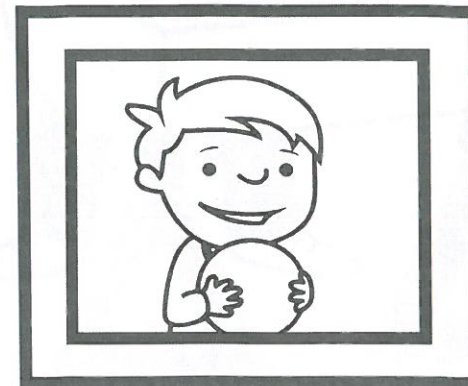
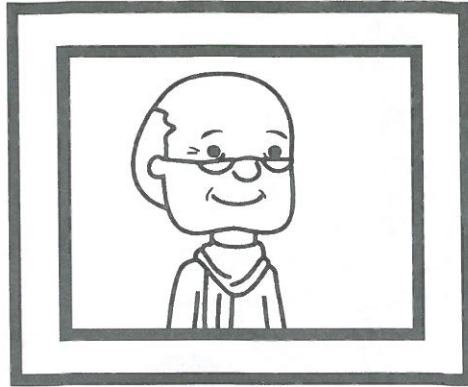

Vocabulary Practice: grandparents, father, mother, brother, sister

**Circle the baby and the mother.
Trace the shapes.**

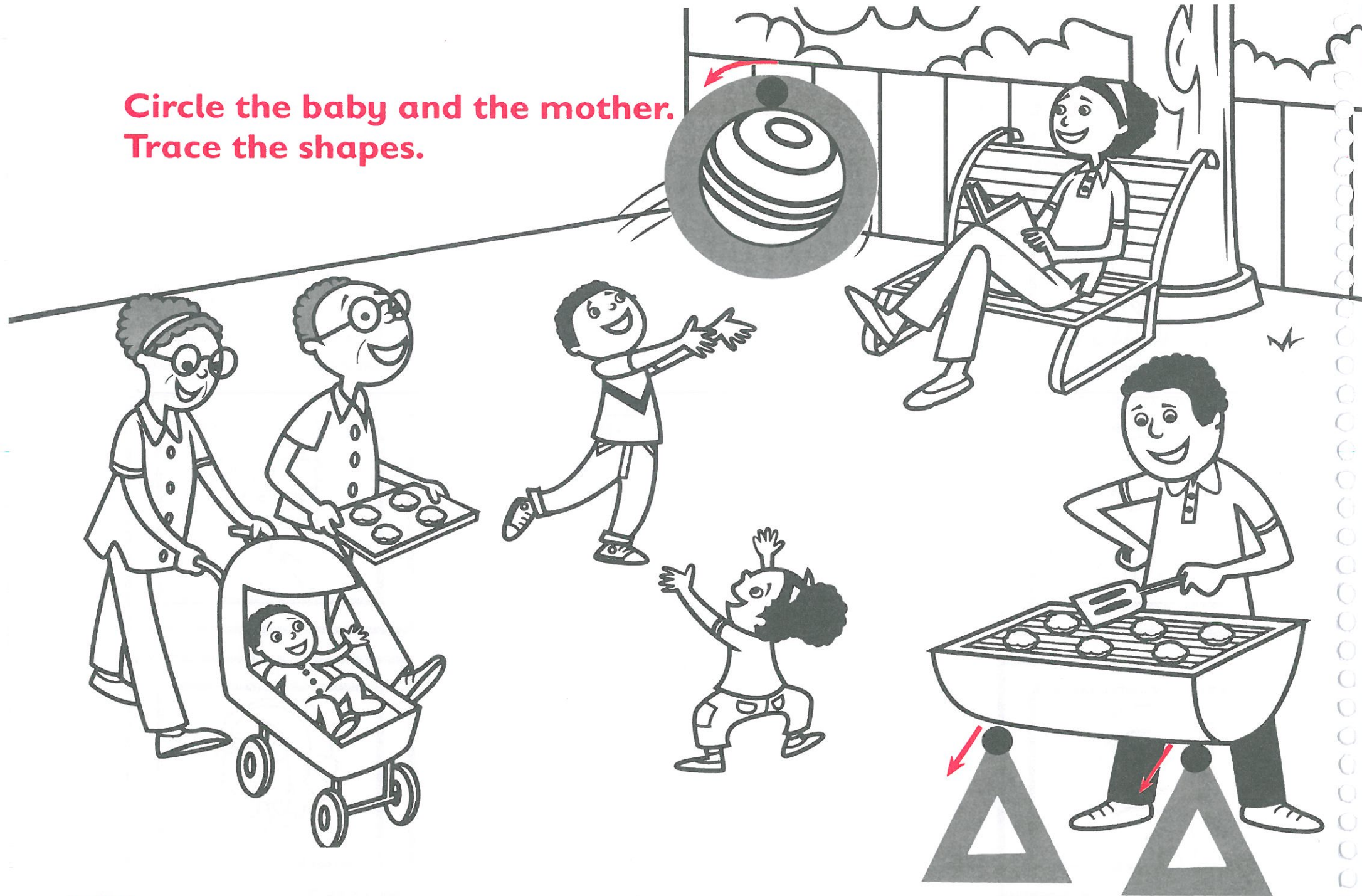

Trace and color.

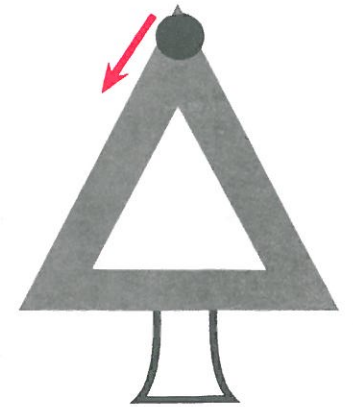
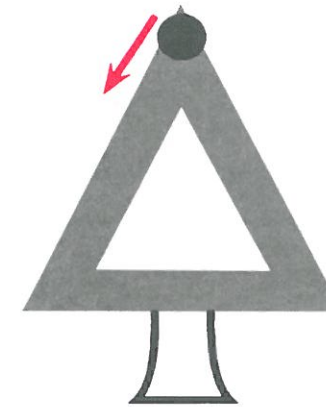
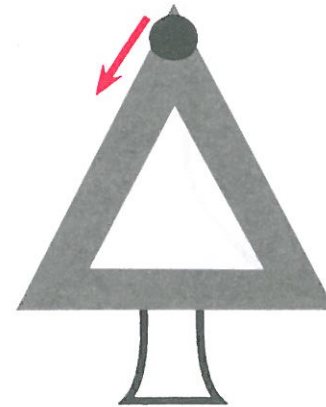
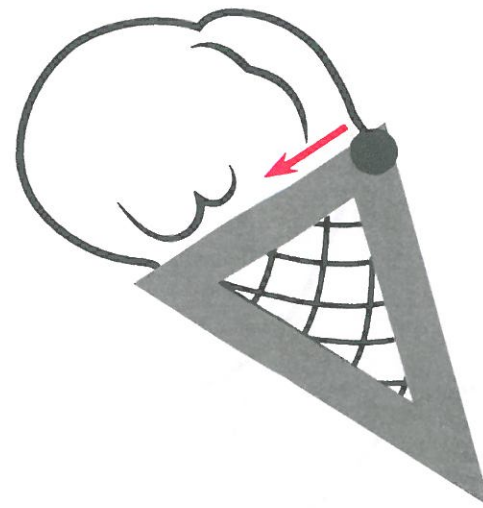
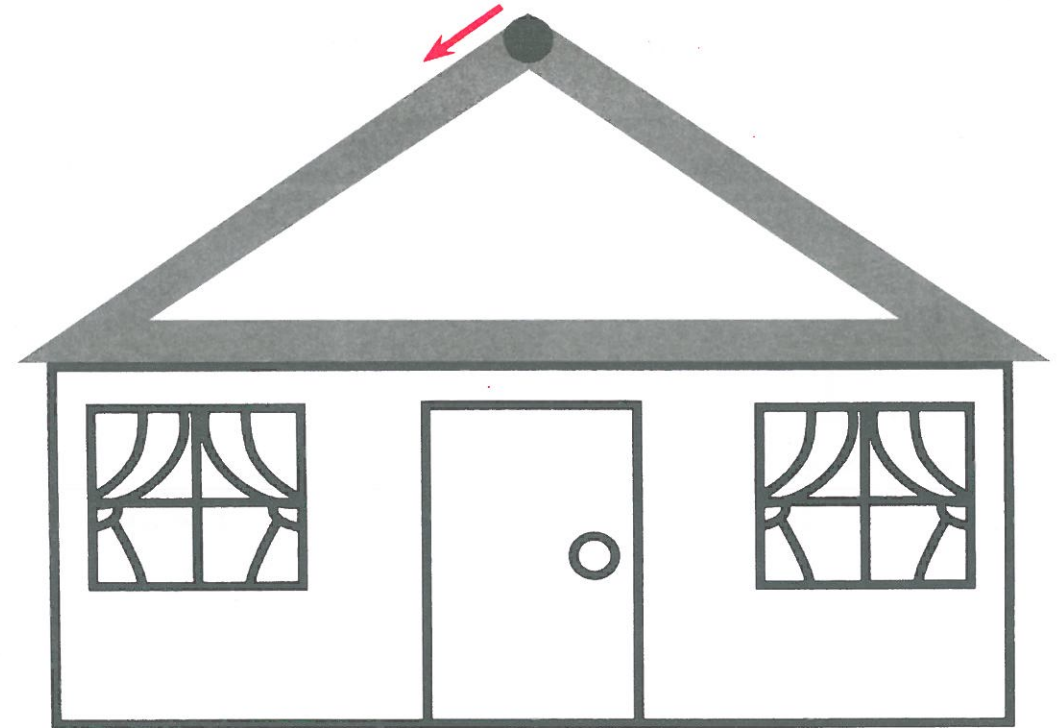
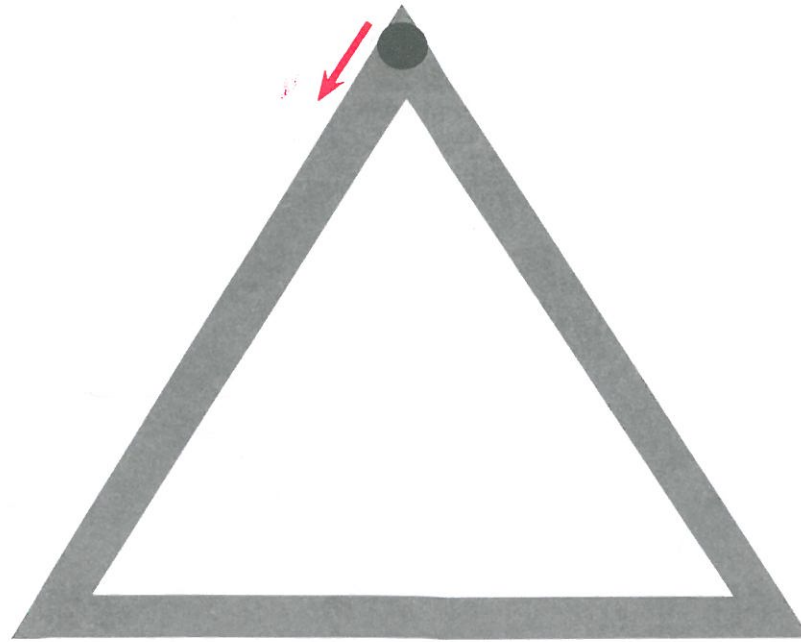

Color the crayon and paste blue paper.

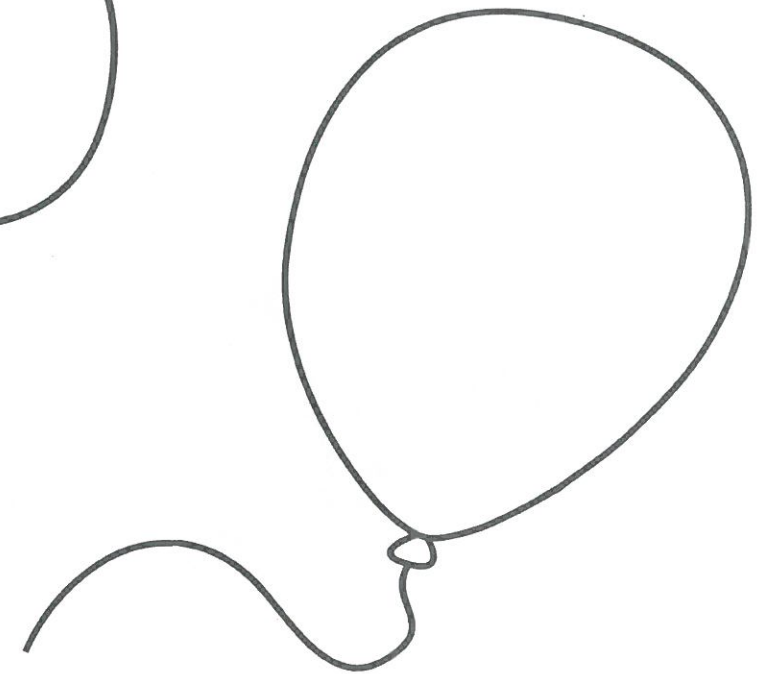
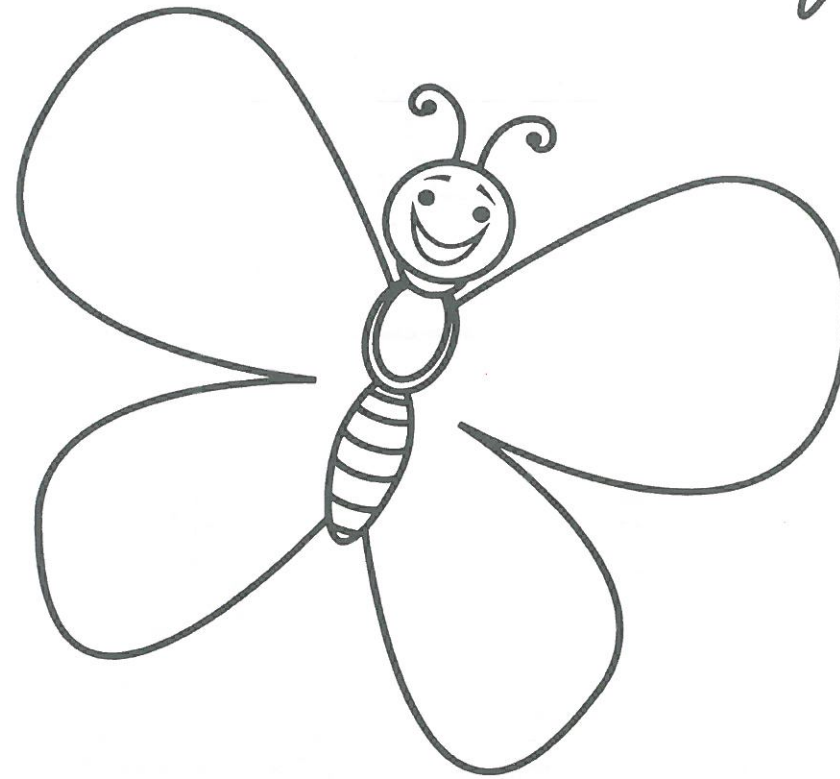
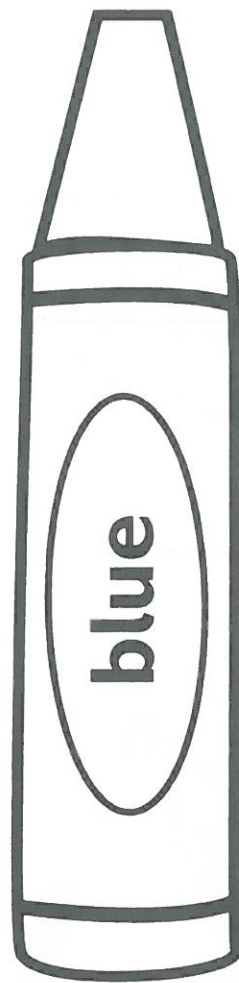



Look and listen. Trace.

My Family

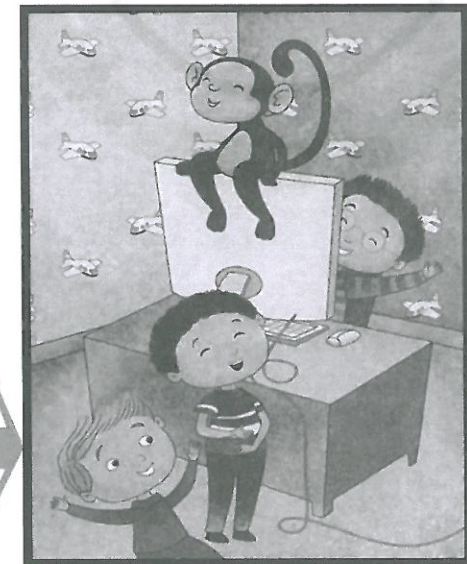
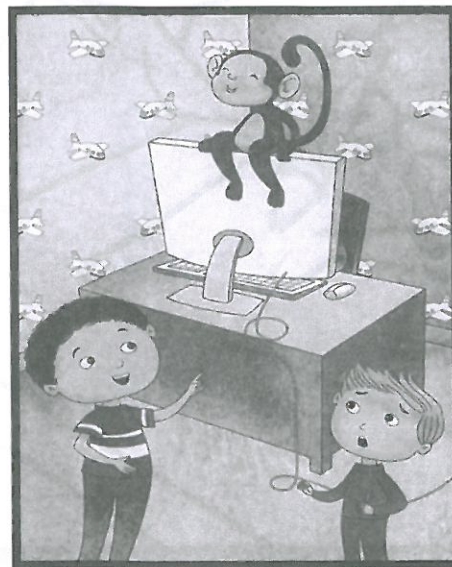
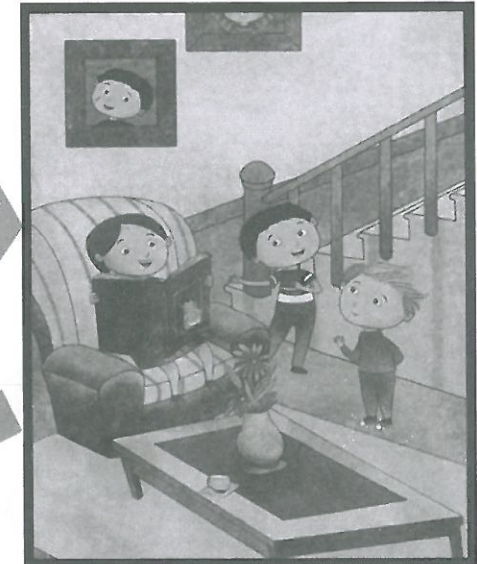

MY FAMILY

Color the triangles. Draw your family.

4

MY TOYS

Find the airplane. Color.

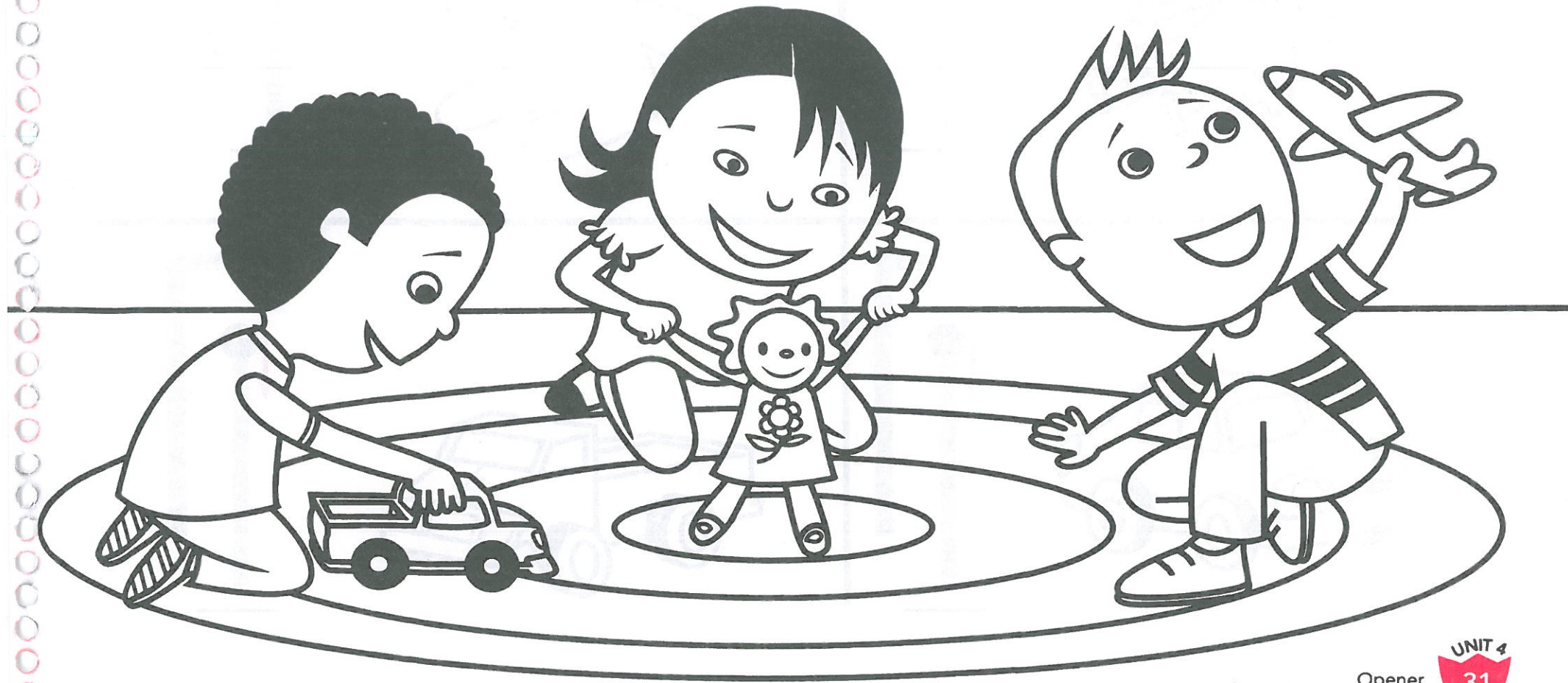

Count. Trace the numbers. Color.

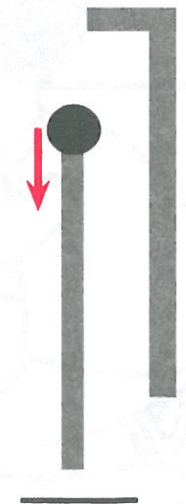
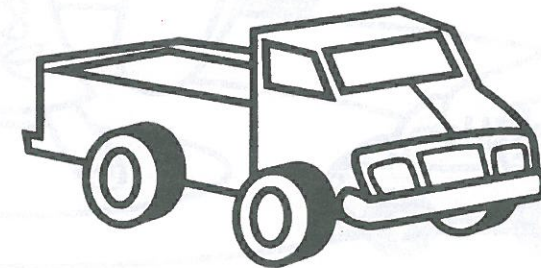
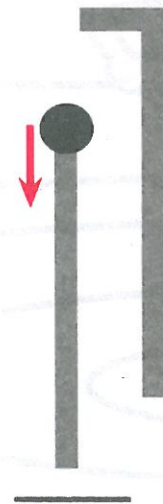
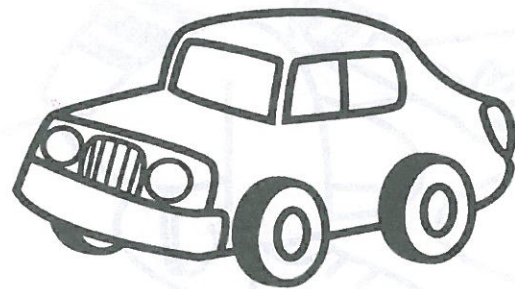
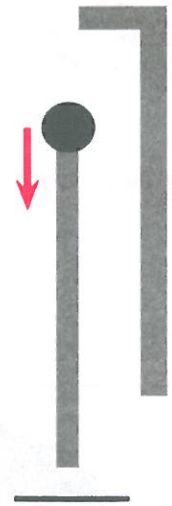
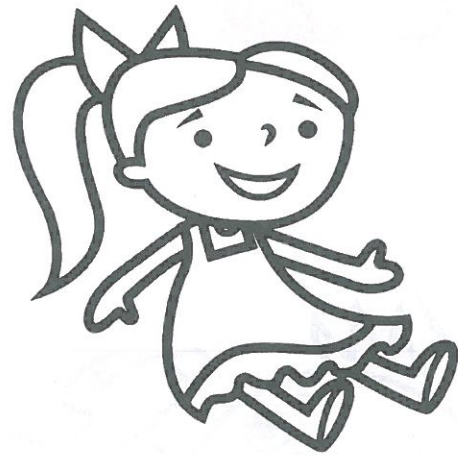

Look and circle the same toy.

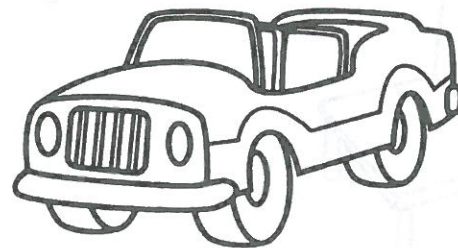
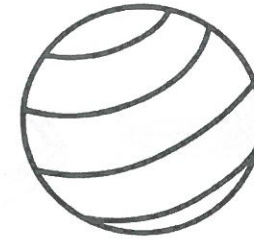
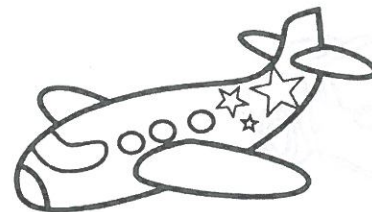
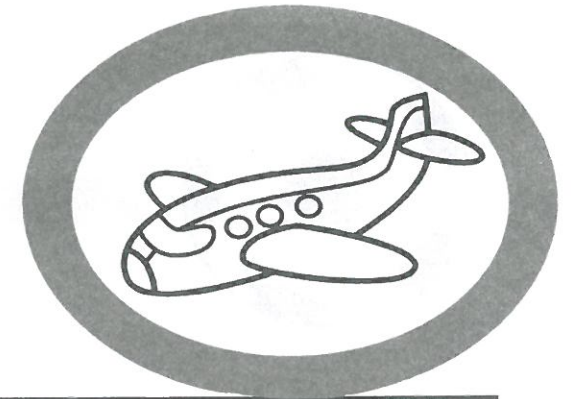
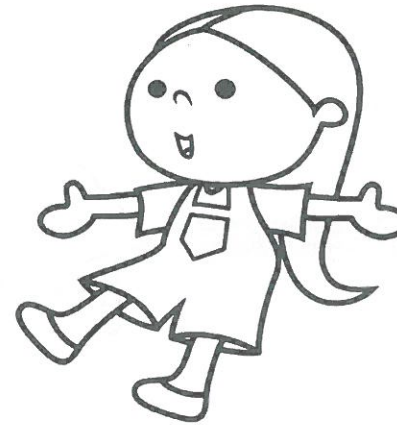
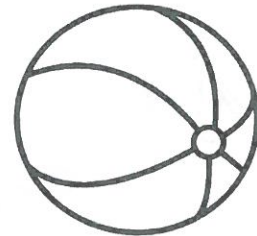
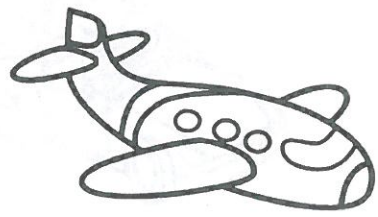

Trace and match.

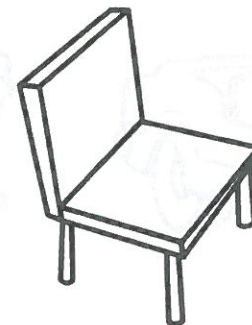
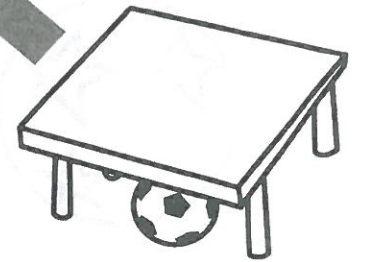
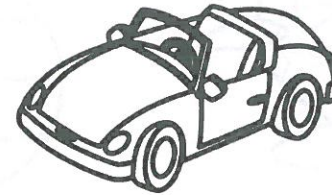
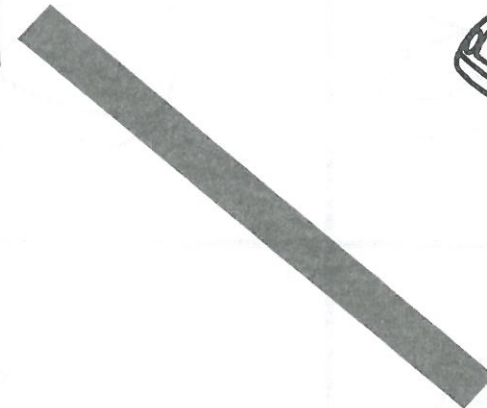
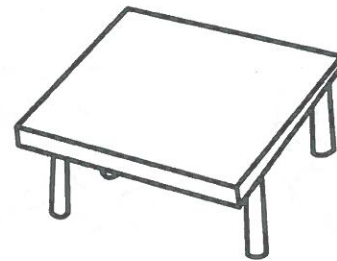

Trace and color.

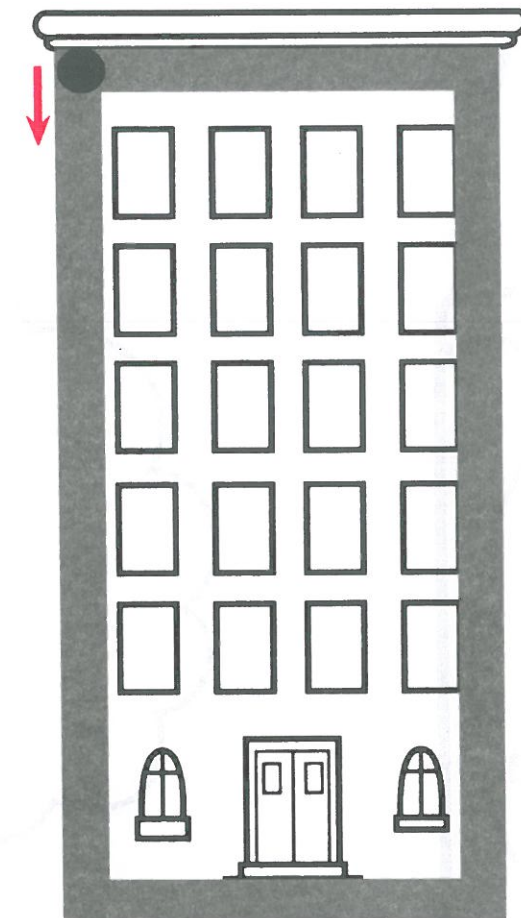
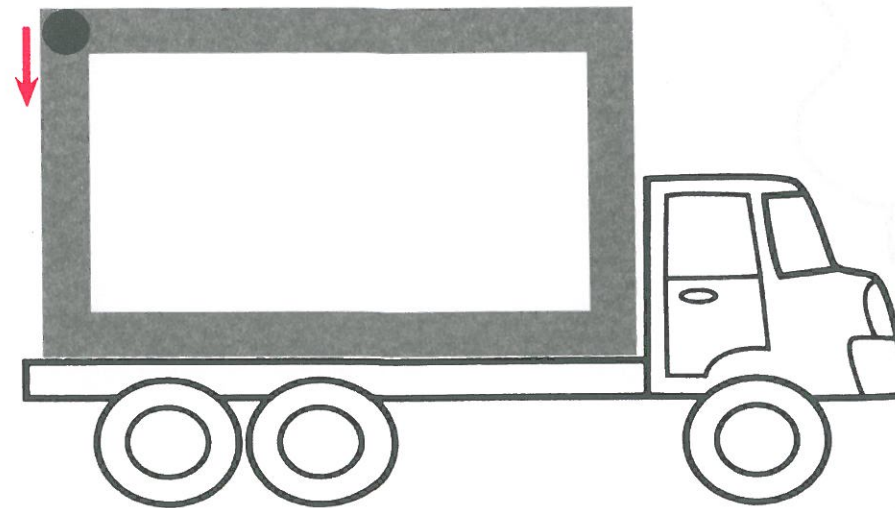
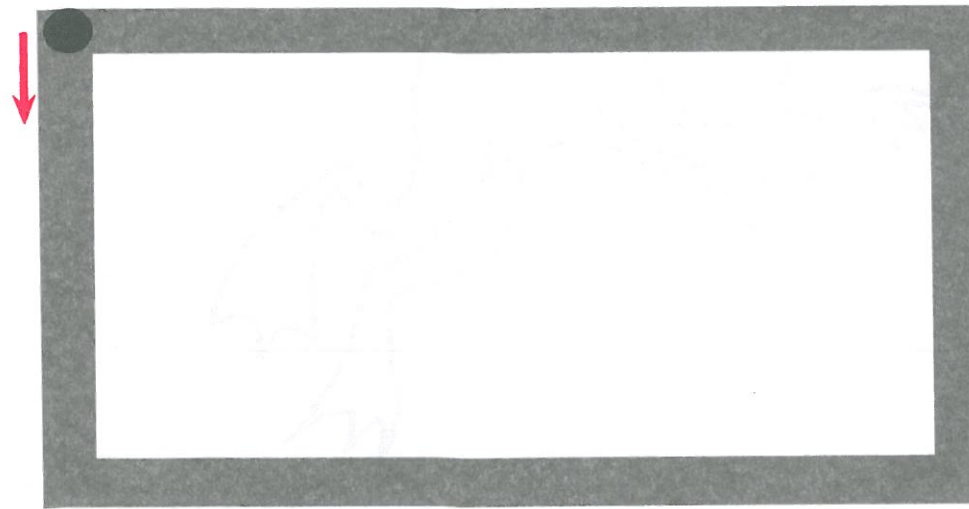

Color and draw something green.

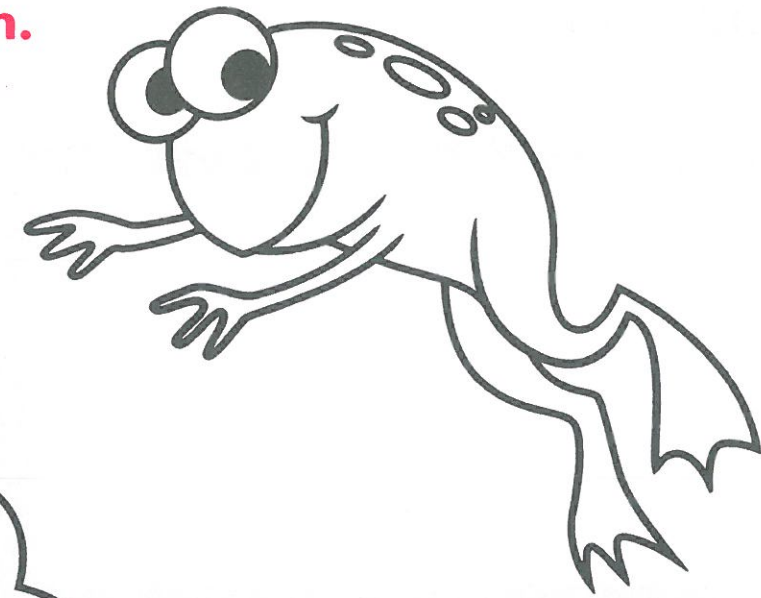
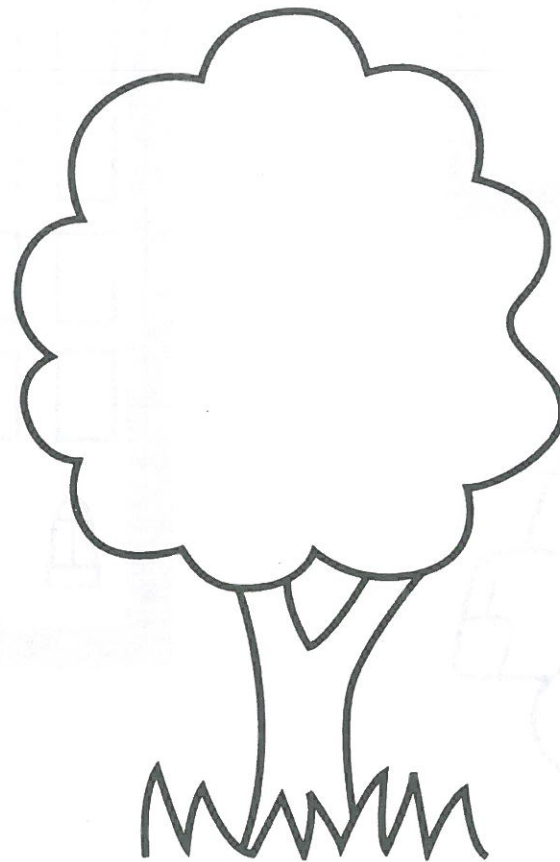
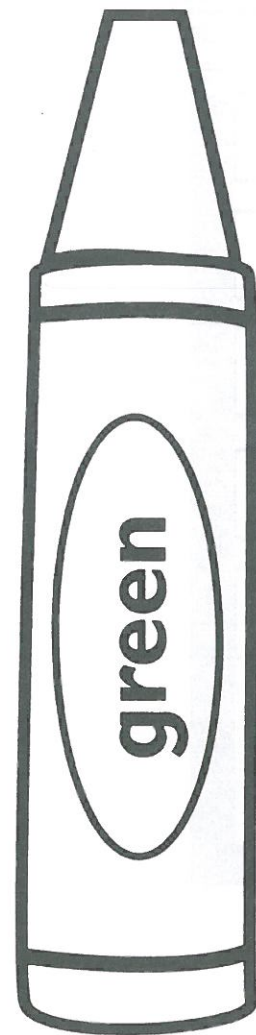



Look and listen. Trace.

Dollhouse

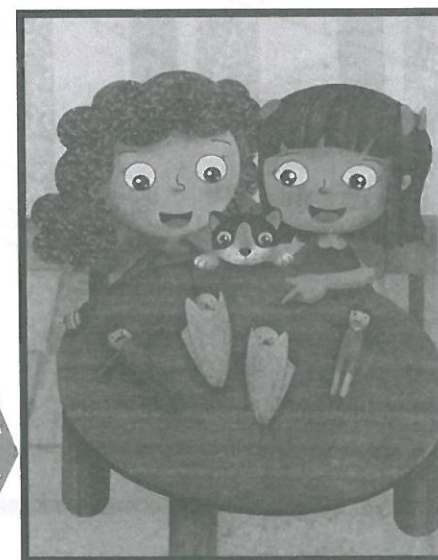
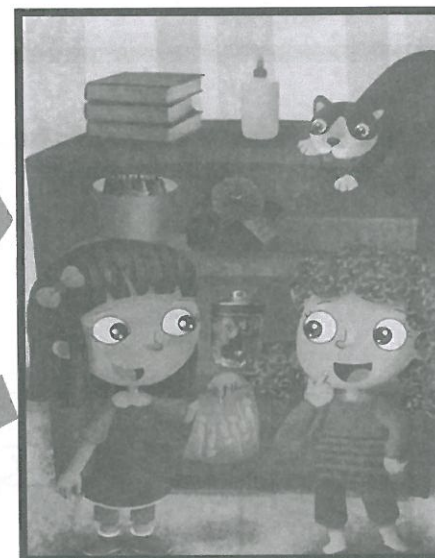
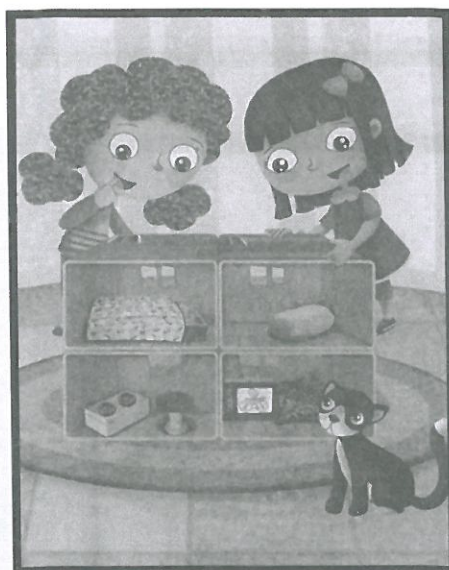

VALUES

Who is sharing? Color the frame.

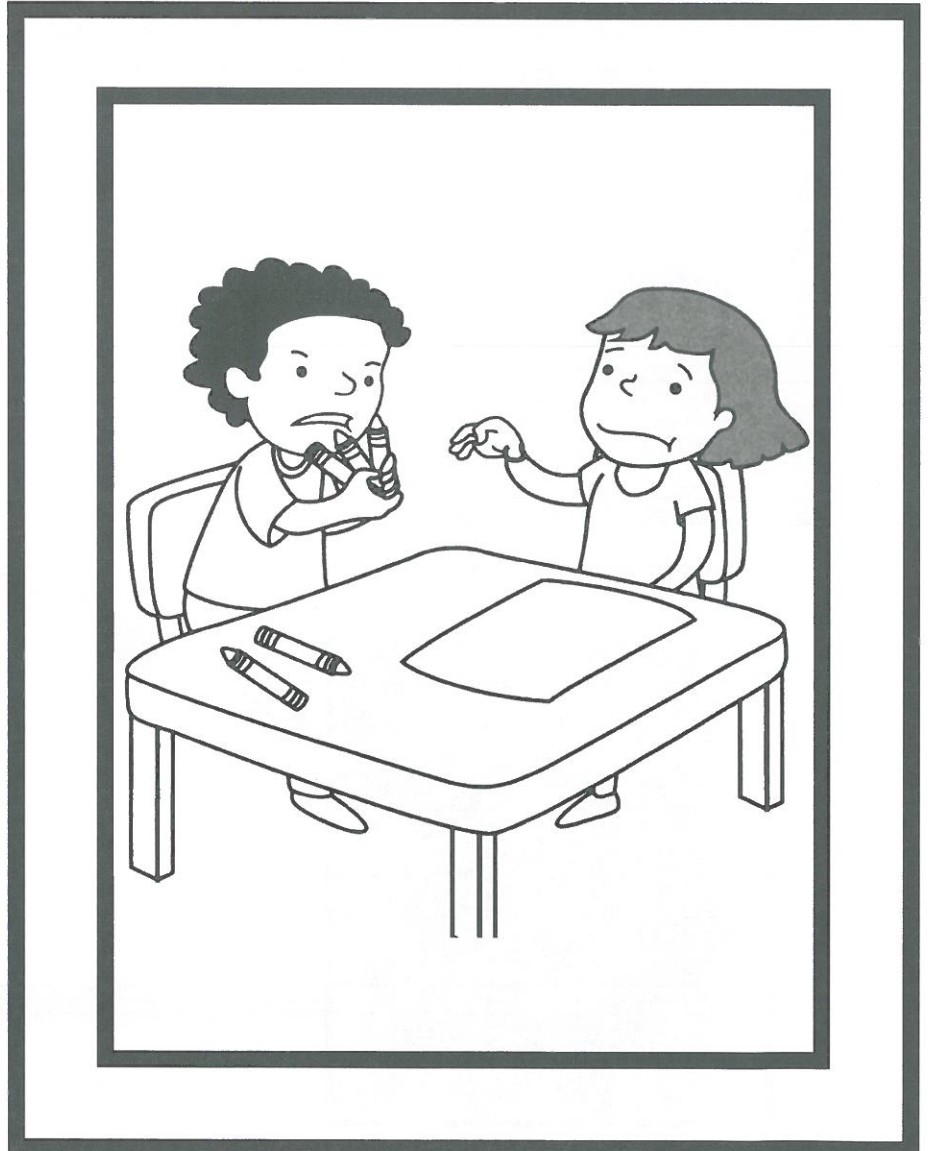
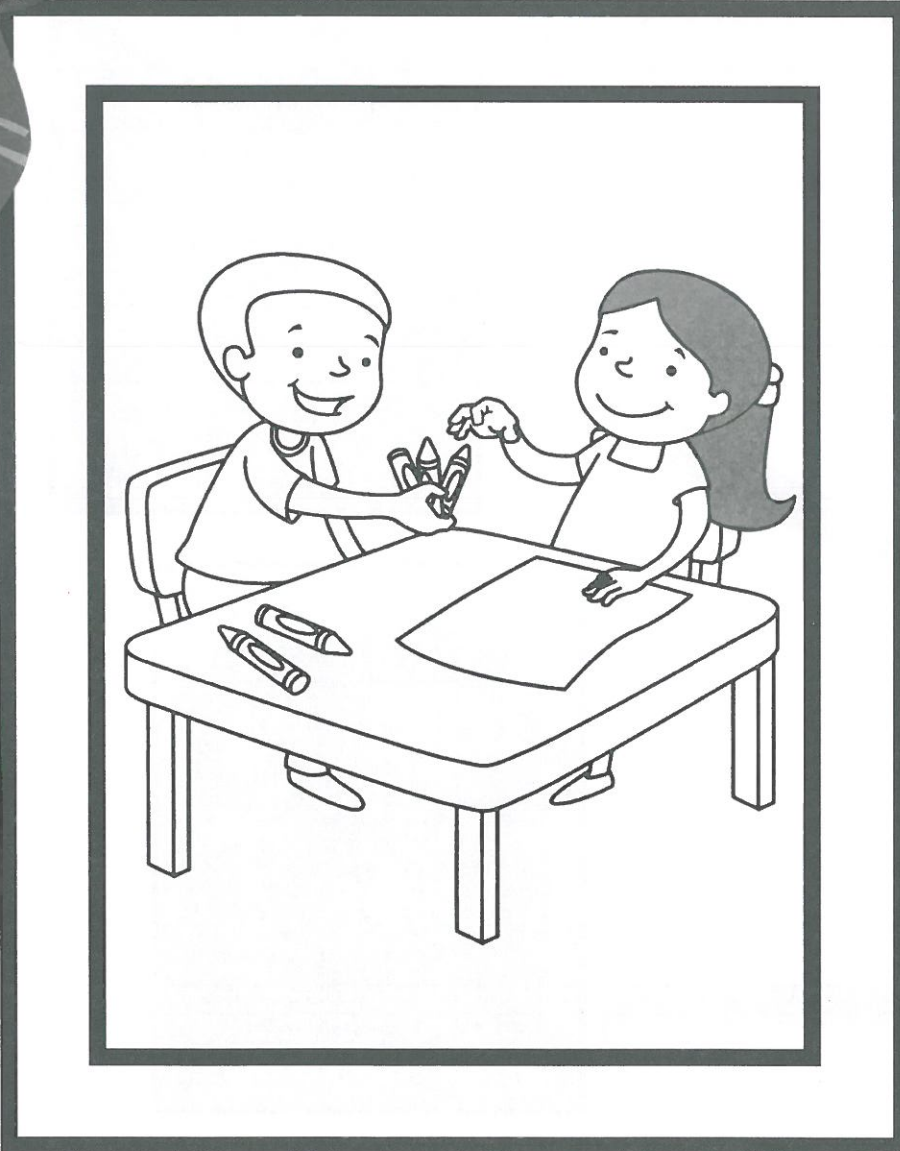

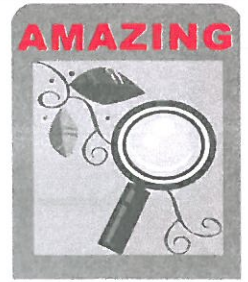

Trace and color. Paste string.

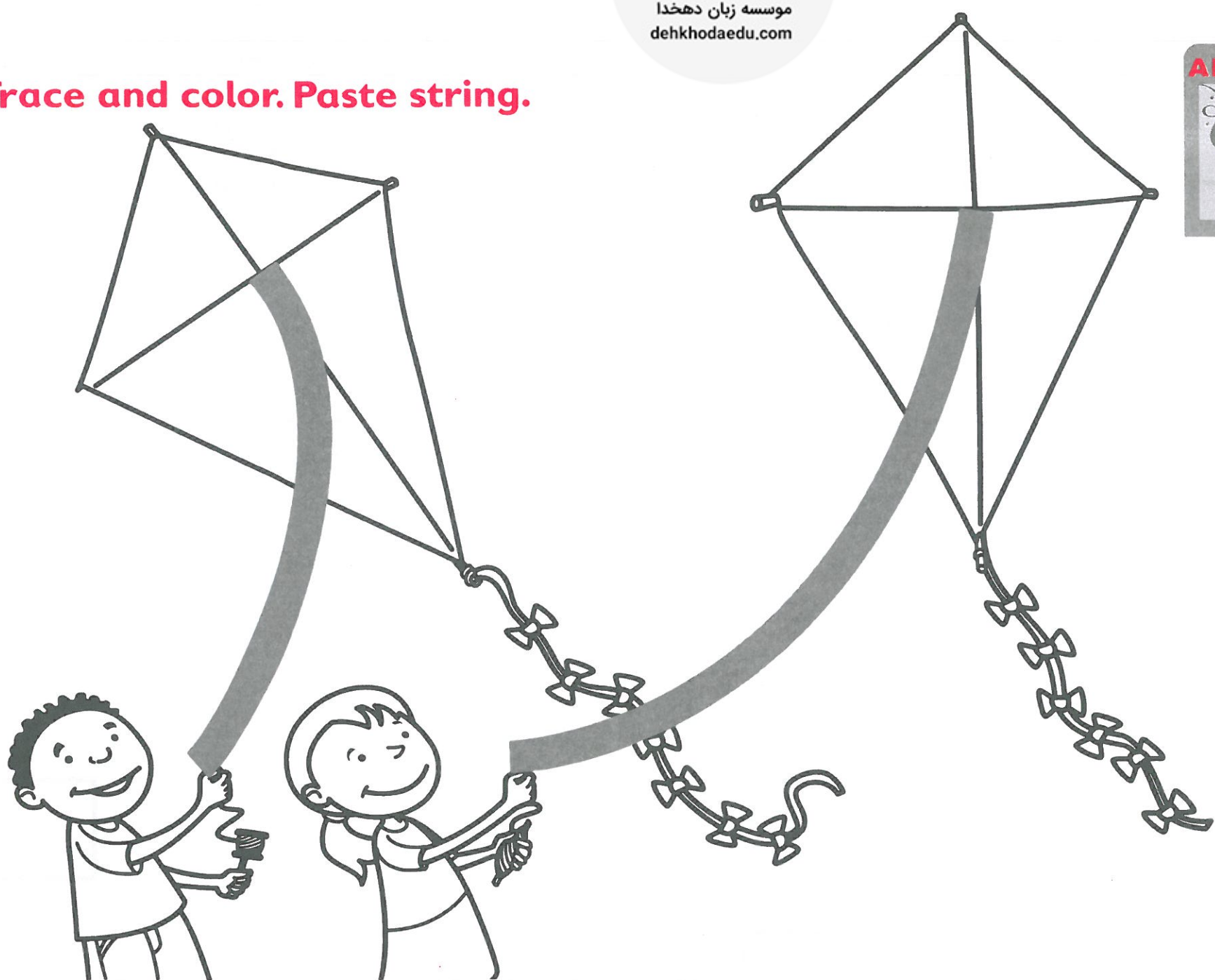

MY TOYS

Color the rectangles. Draw your toys.



Personal Response



5

MY LUNCH

Find the carrot. Color.

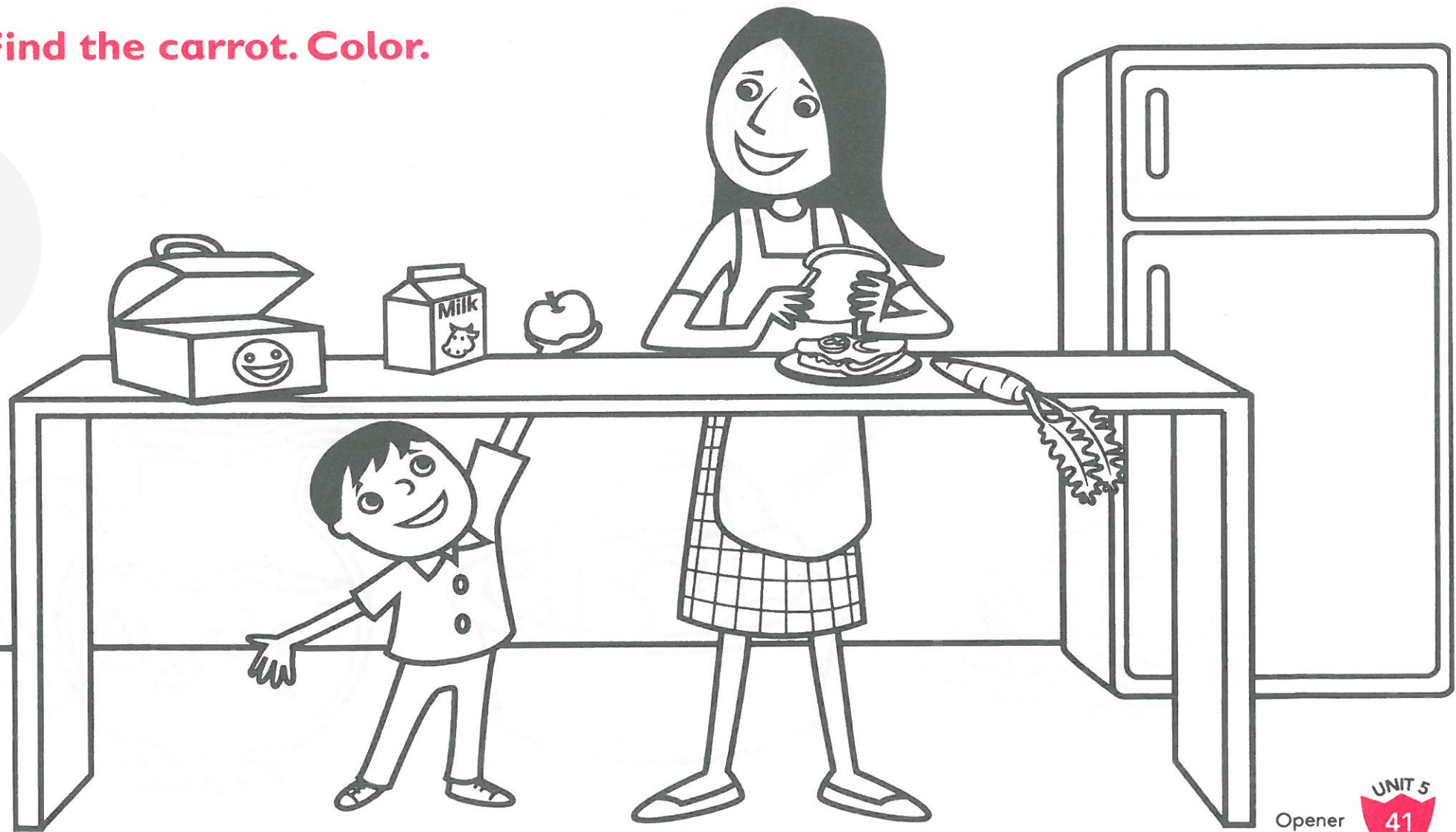

Match and color.

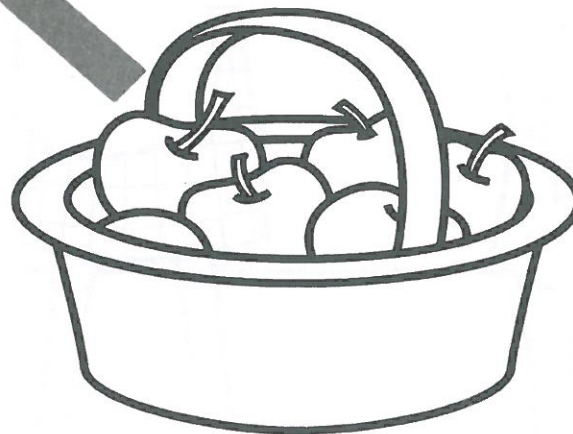
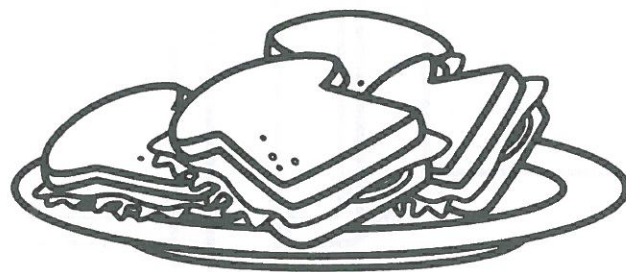
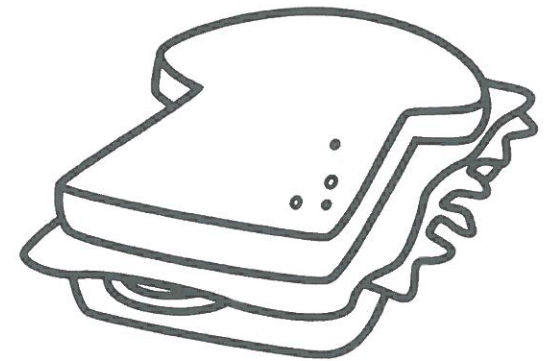
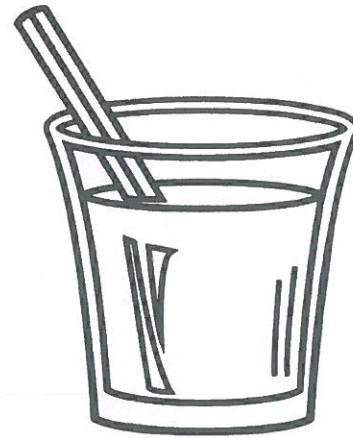
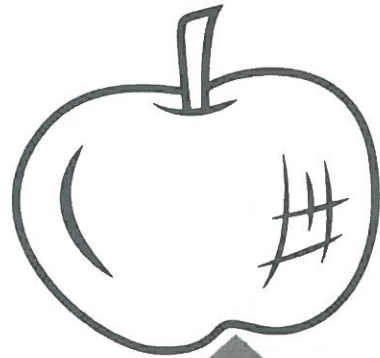

Count and match. Color the food.

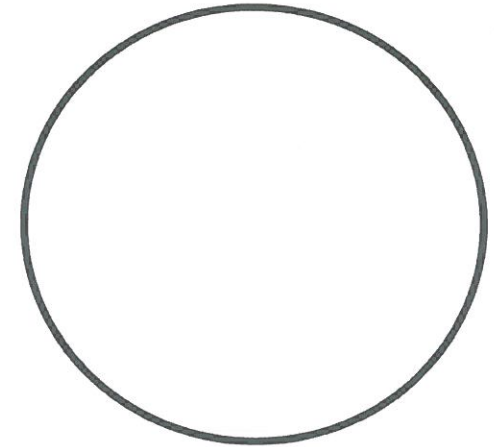

2

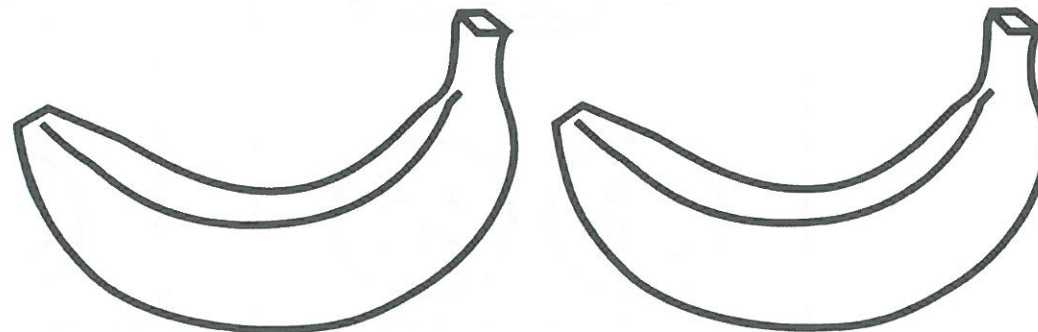

What food do you like? Color the faces.

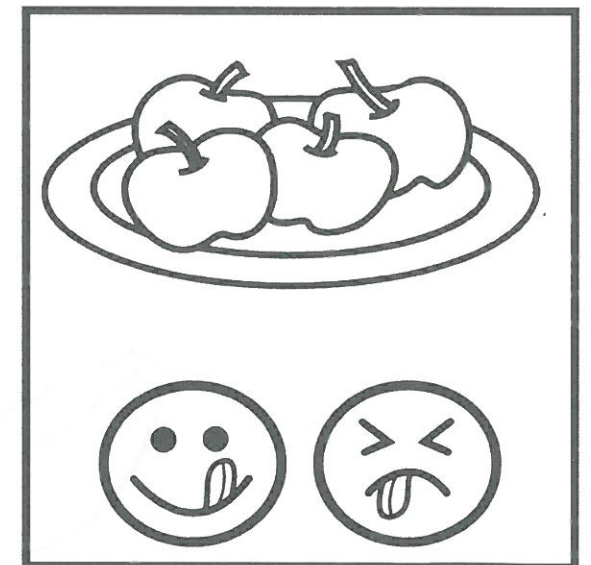
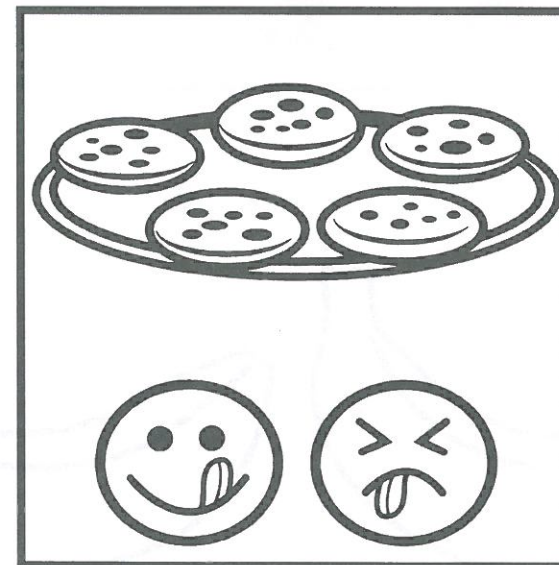
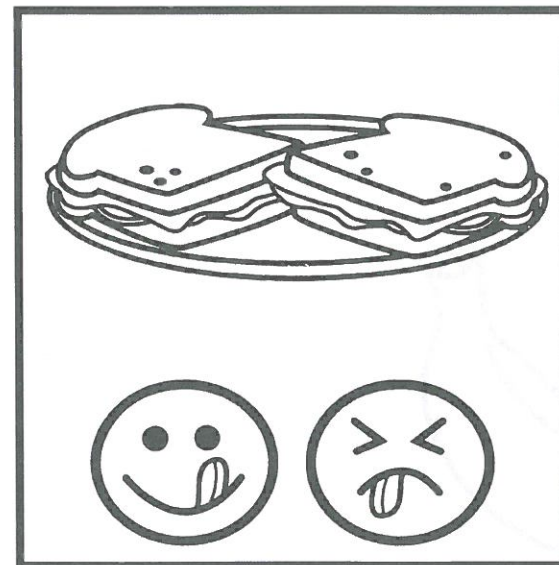
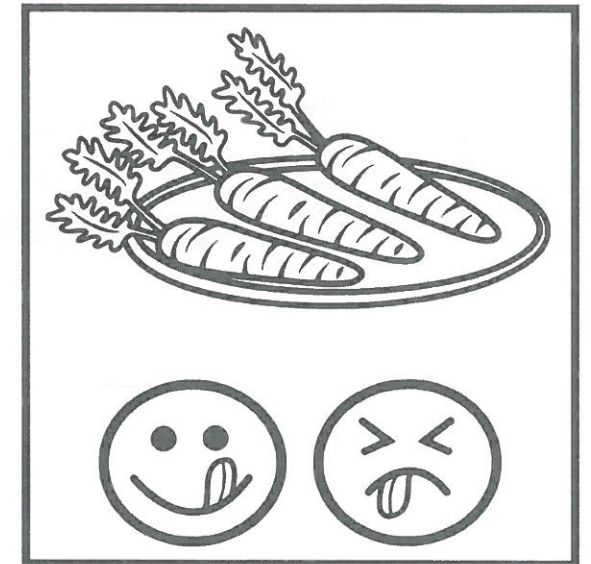
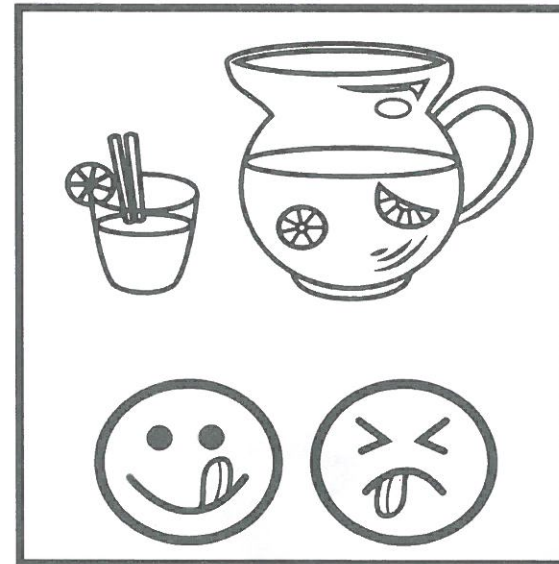

Trace. Color shapes in the train.

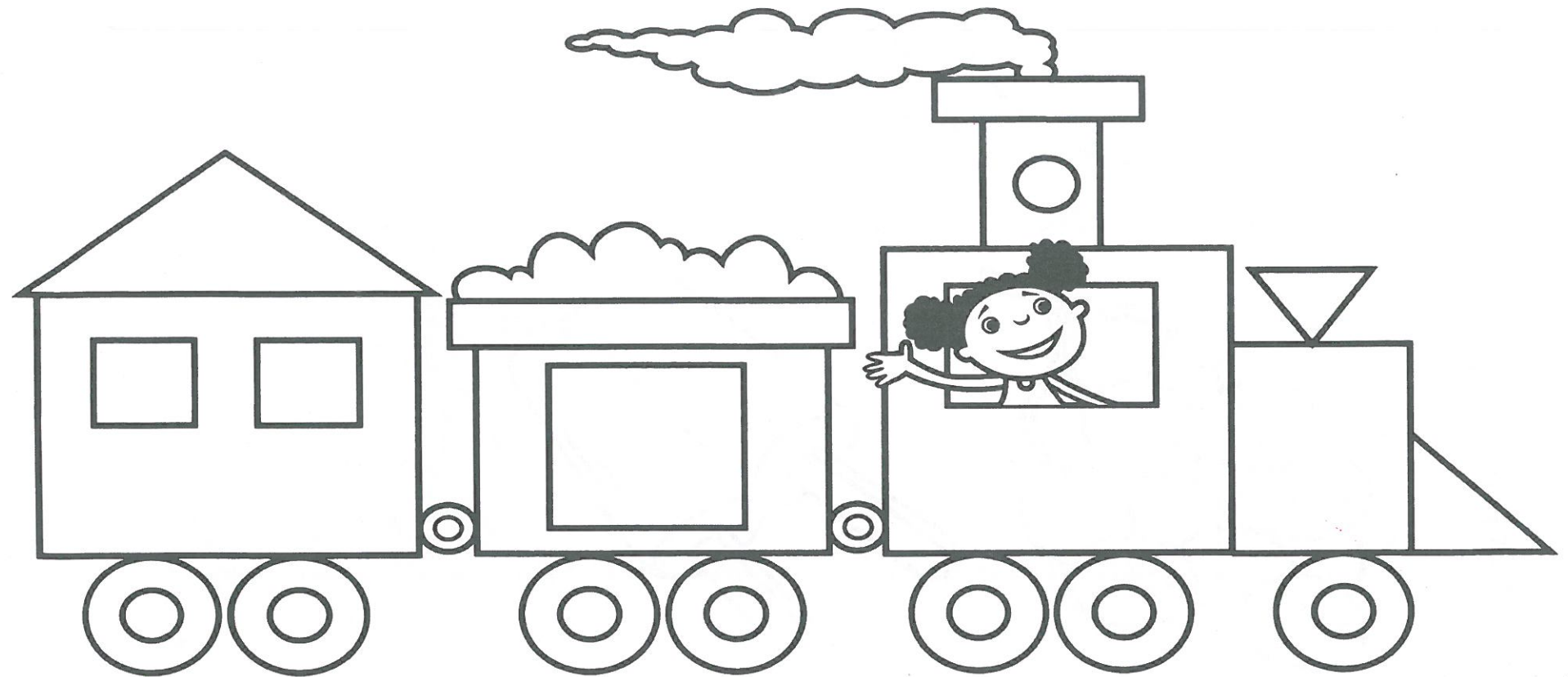
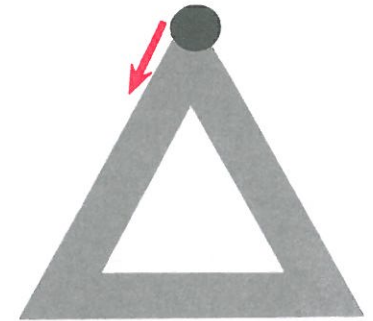
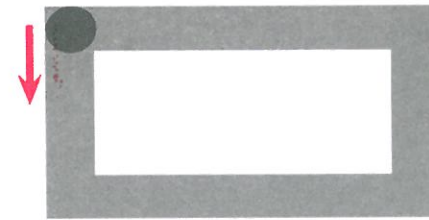
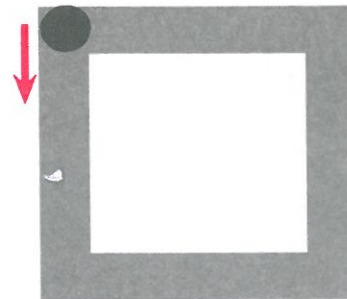
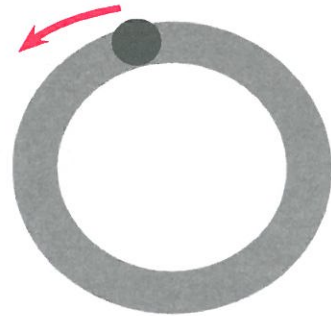

Shapes Practice: circle, square, rectangle, triangle

VALUES

Who is trying something new? Color the frame.

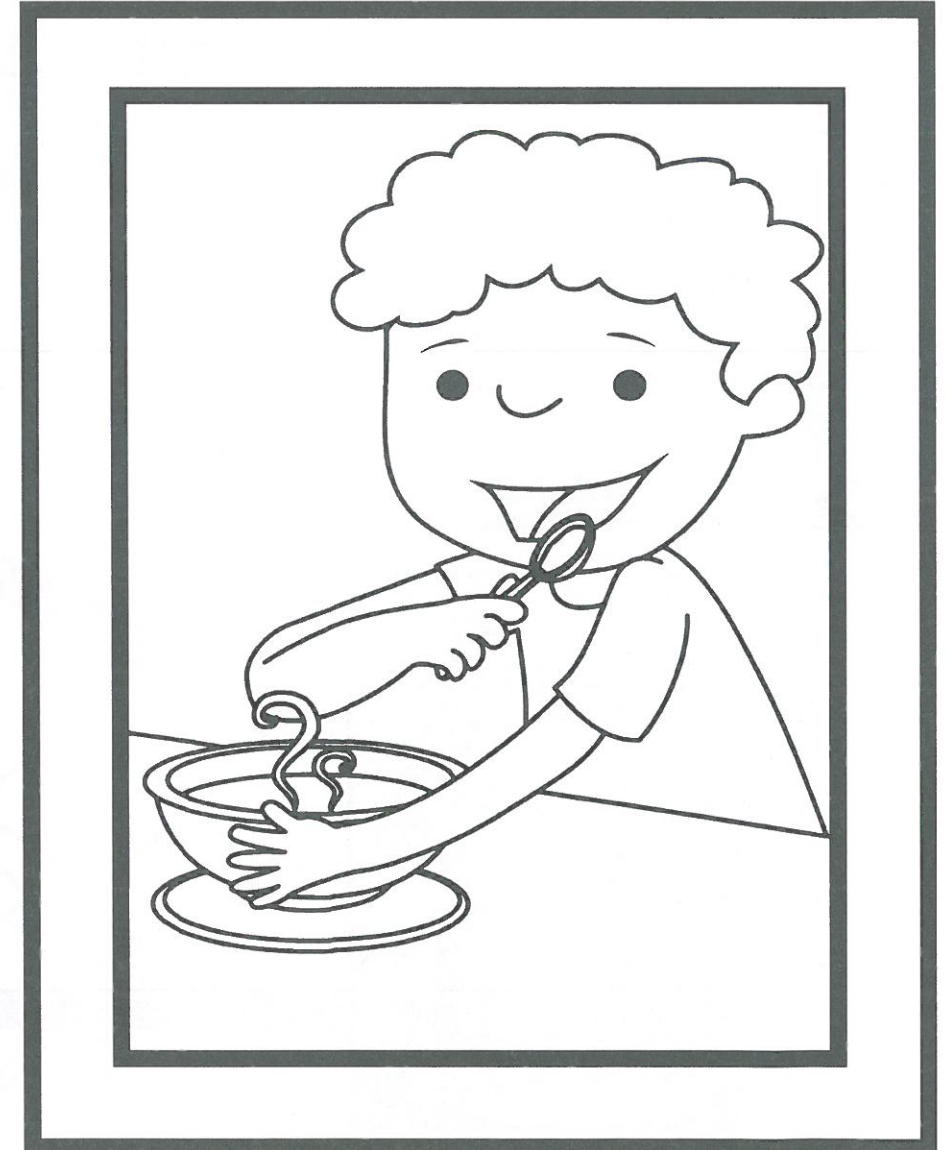

Match and color.

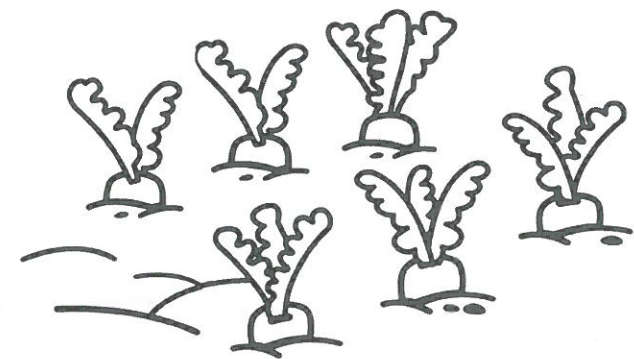
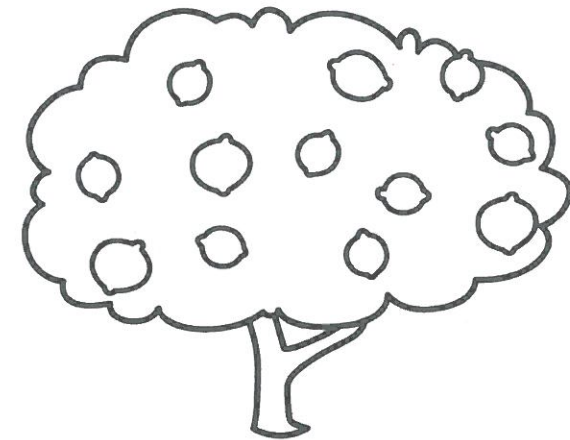
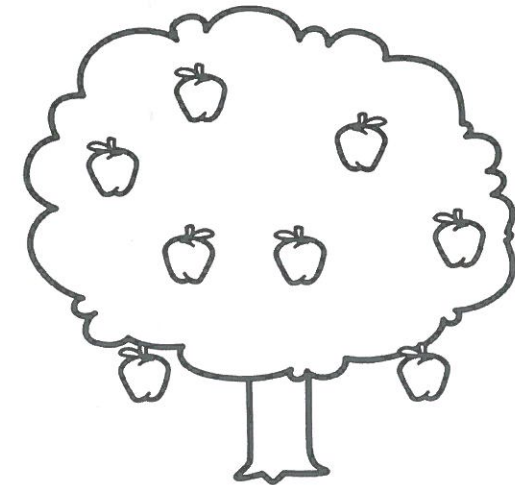
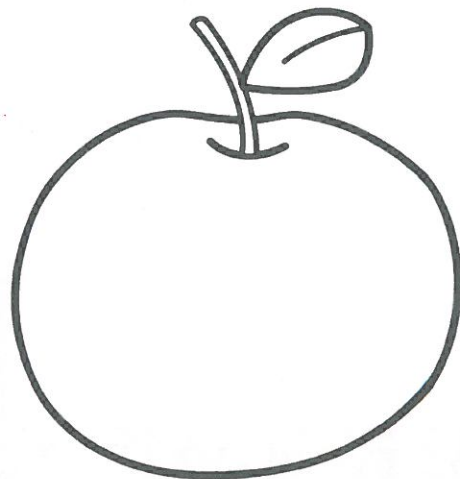
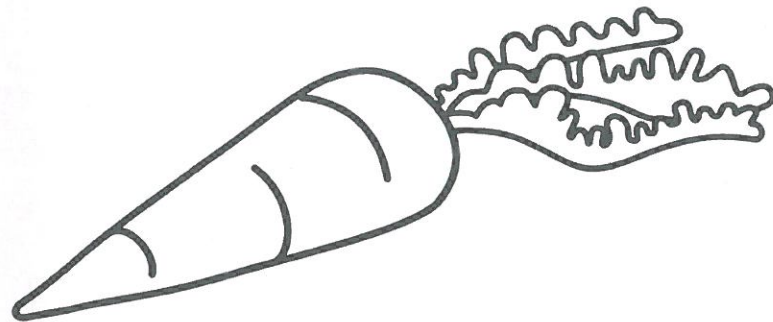
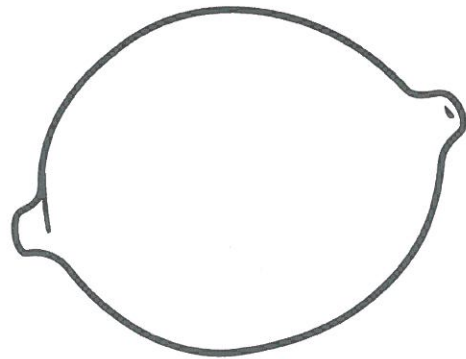

Amazing: Science Connection: lemon, lemon tree, carrot, apple, apple tree

MY LUNCH

Color the shapes. Draw your lunch.



Personal Response

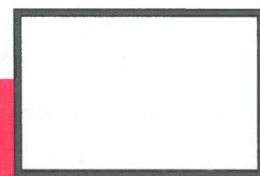

6

MY CLOTHES

Find the skirt. Color.



Look and draw.

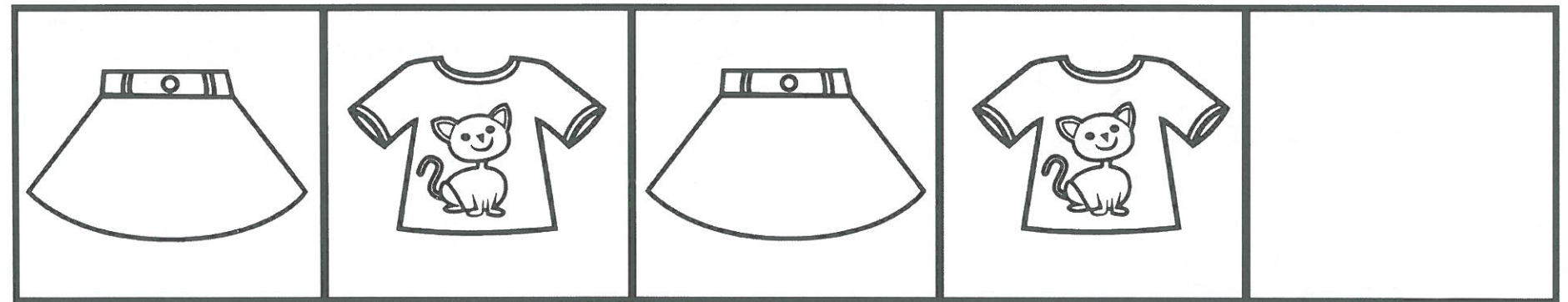

How many? Find three and circle. Color and trace the number.

3



Color the crayons and paste brown and pink paper.

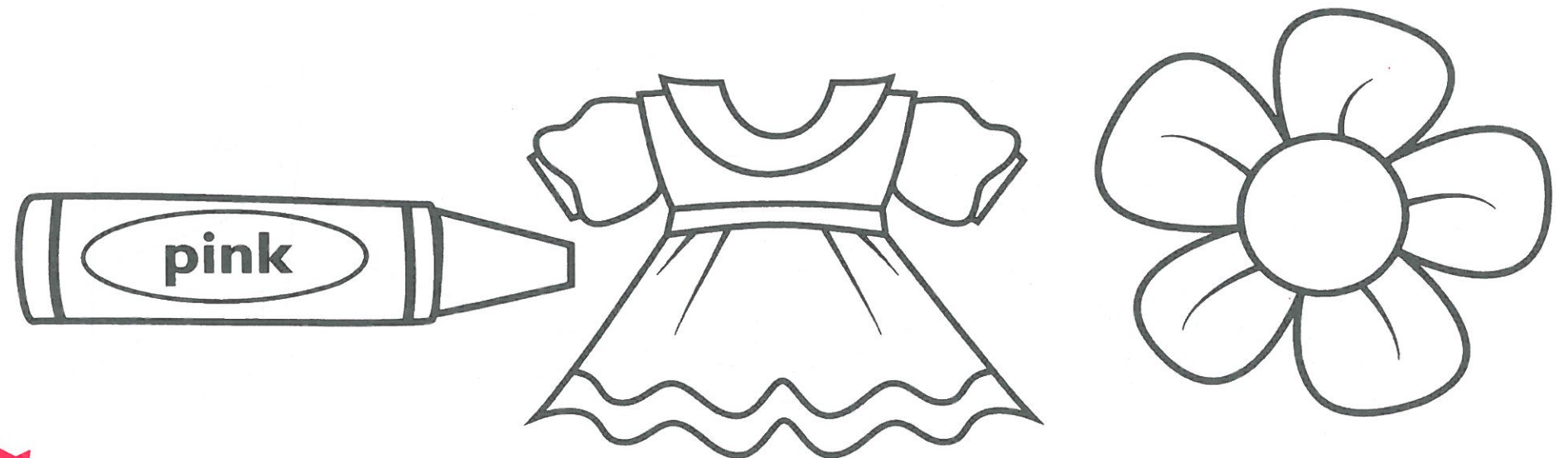
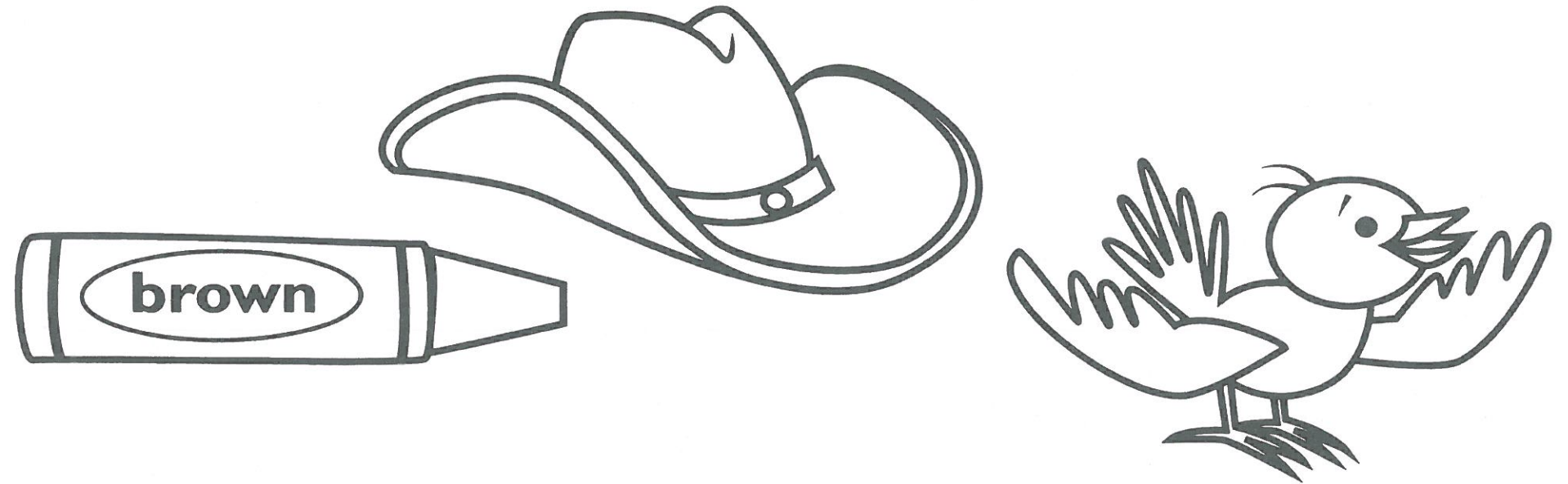



Look and listen. Trace.

Let's Play

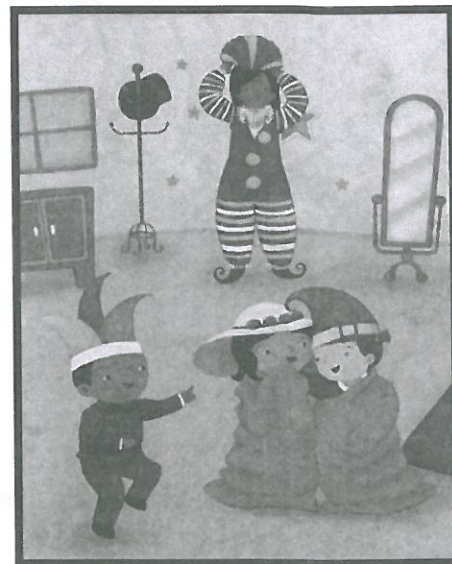
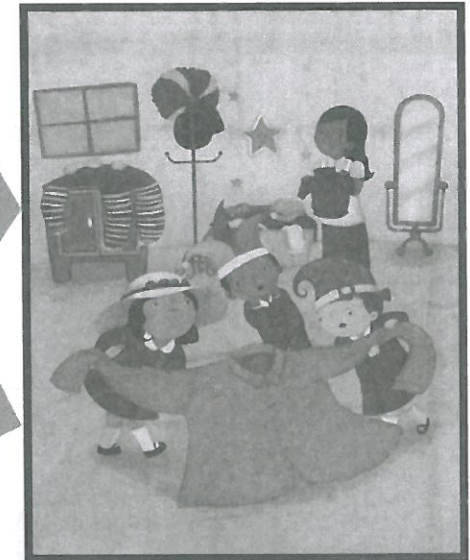

VALUES

Who is helping? Color the frame.

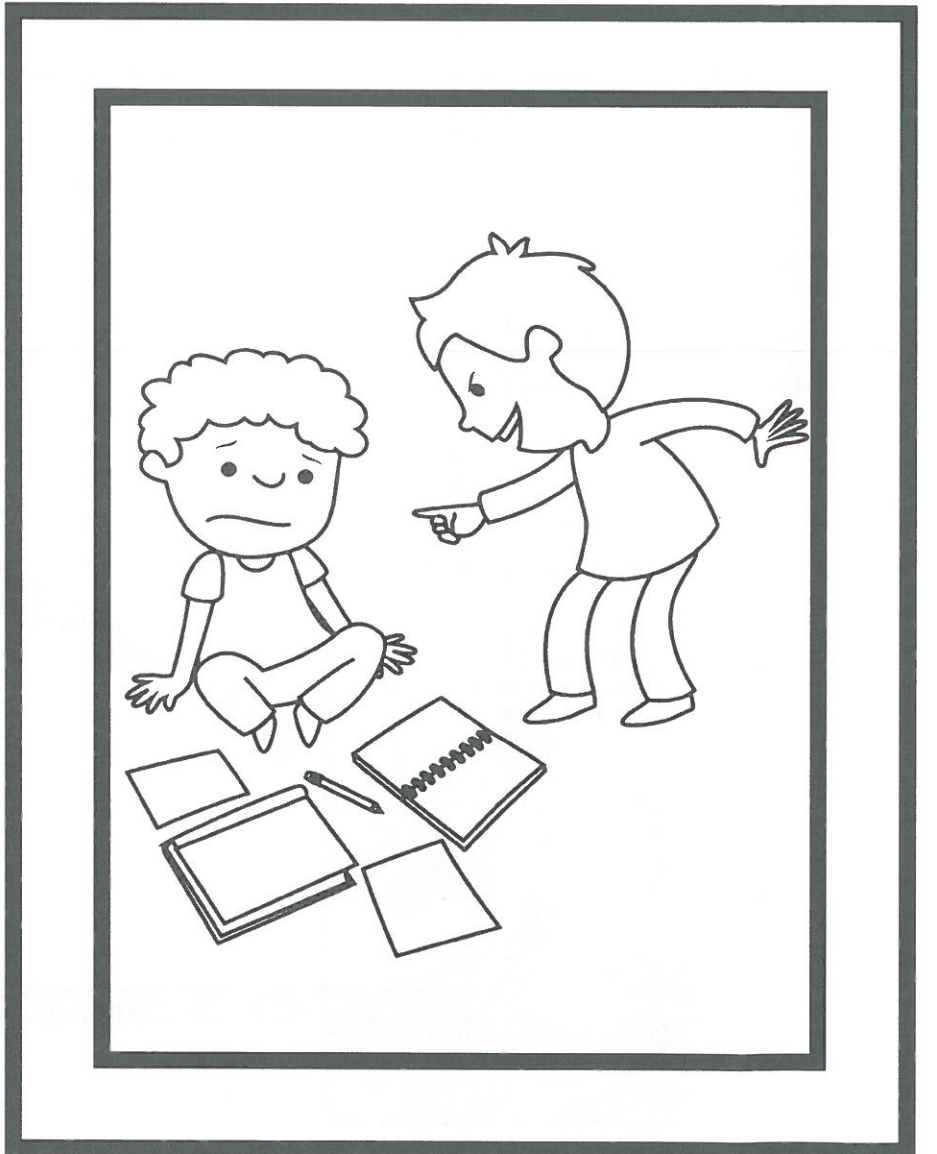

Draw more rain. Color.

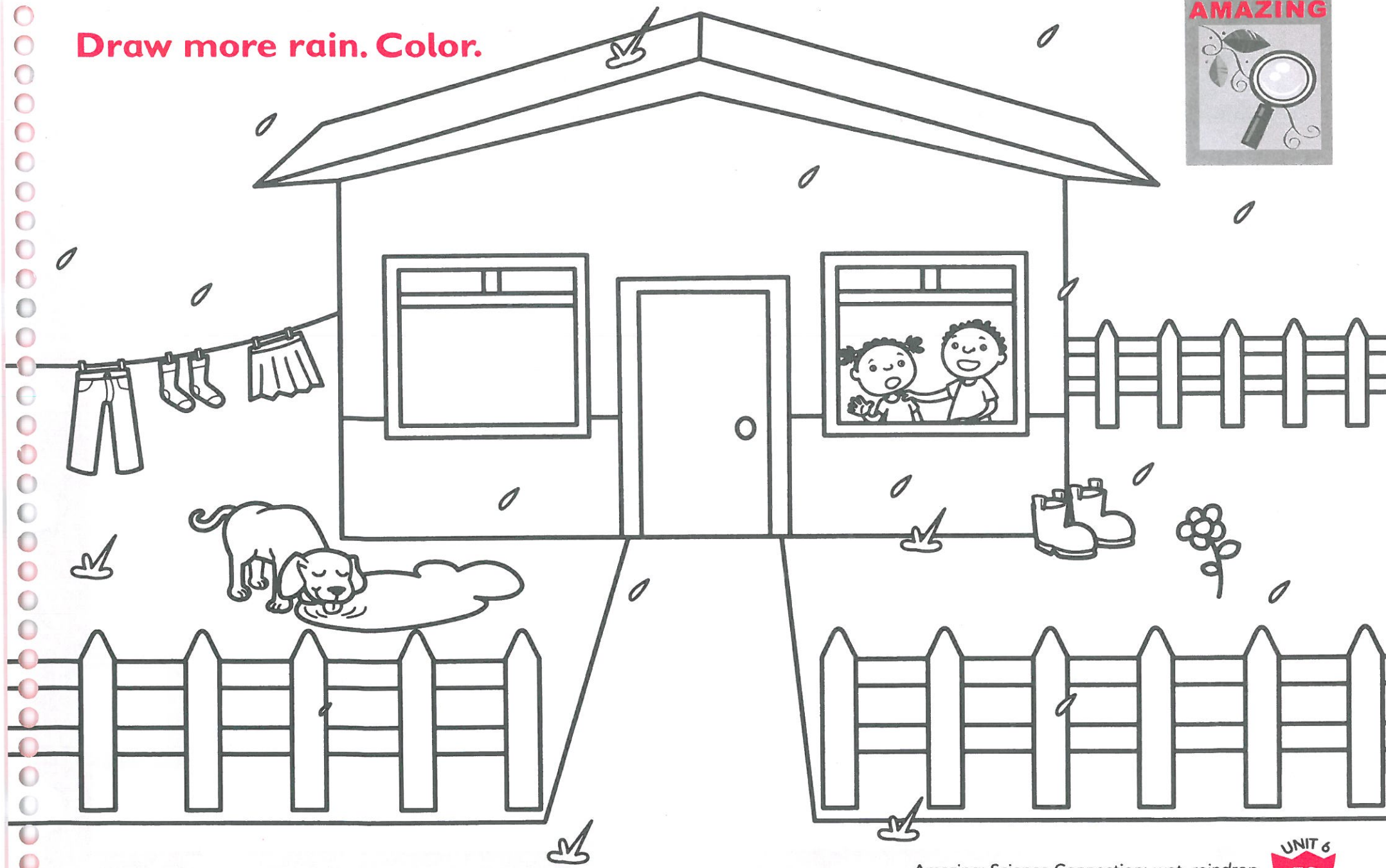



MY CLOTHES



Trace the shapes. Draw clothes.

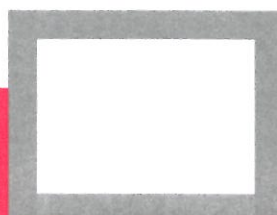

7

ANIMALS

Circle the dog and bird. Color.

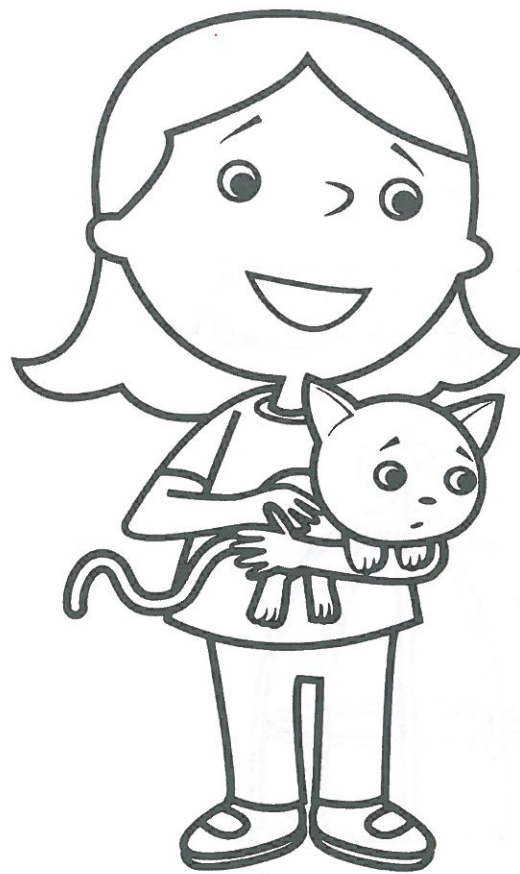

Match and color.

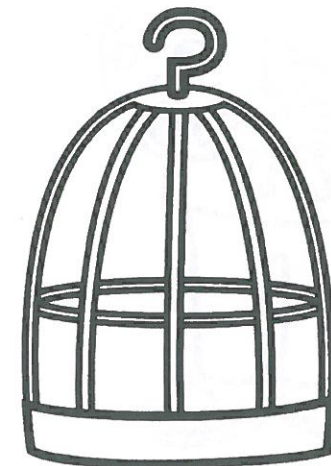
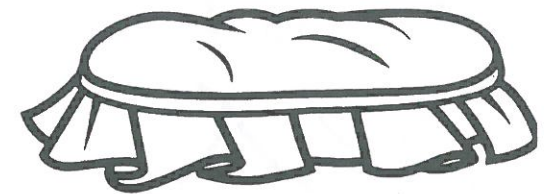
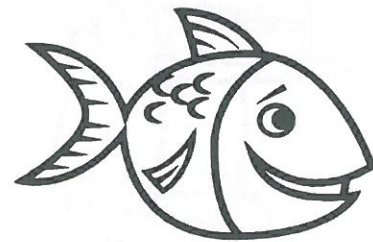
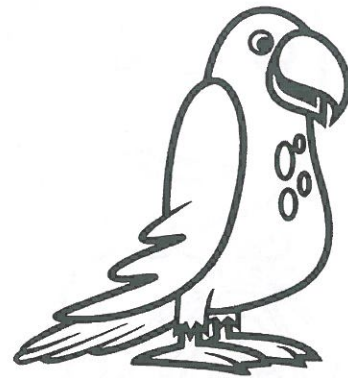
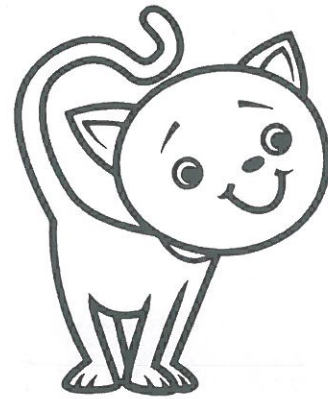

Trace and color.

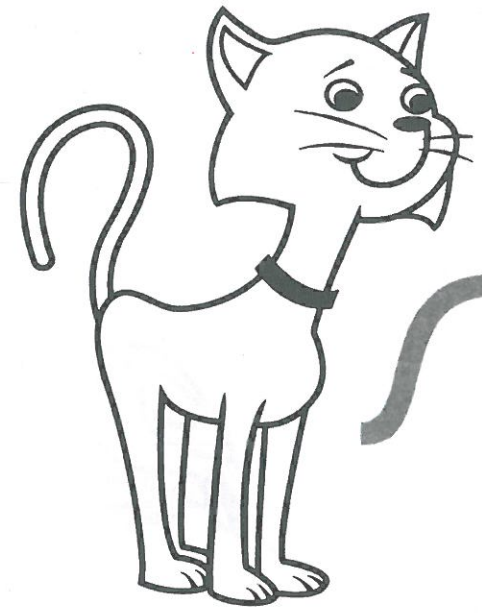
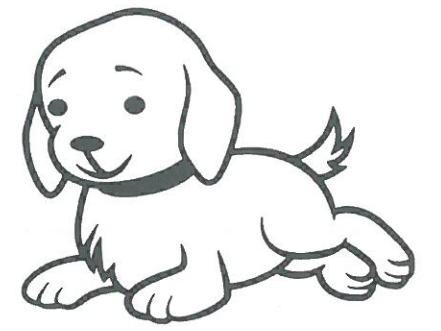
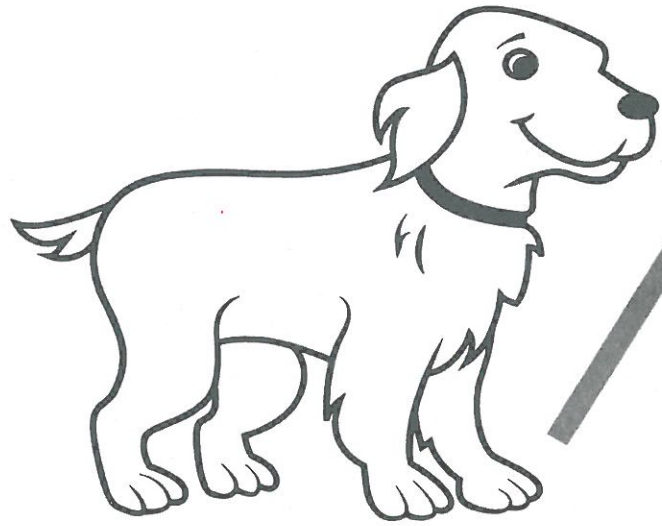

Look and match.

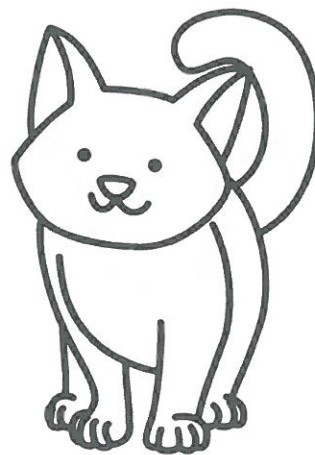
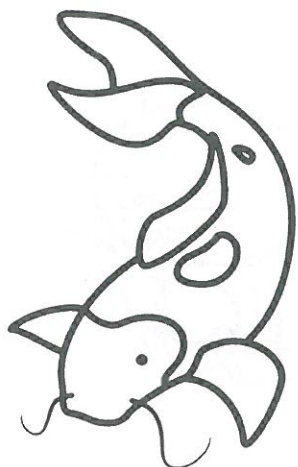
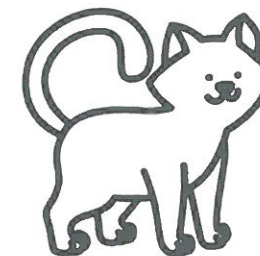
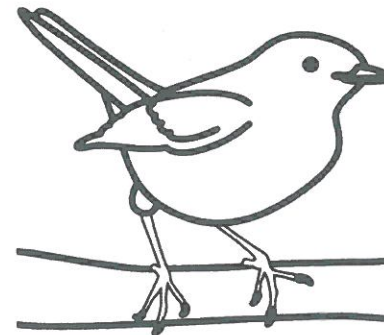
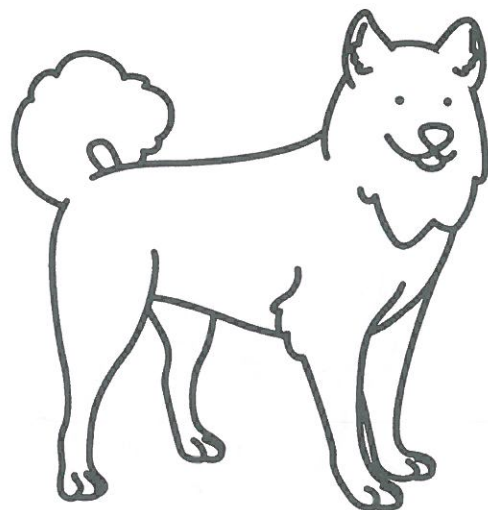

How many? Count the fish and trace the number. Color.

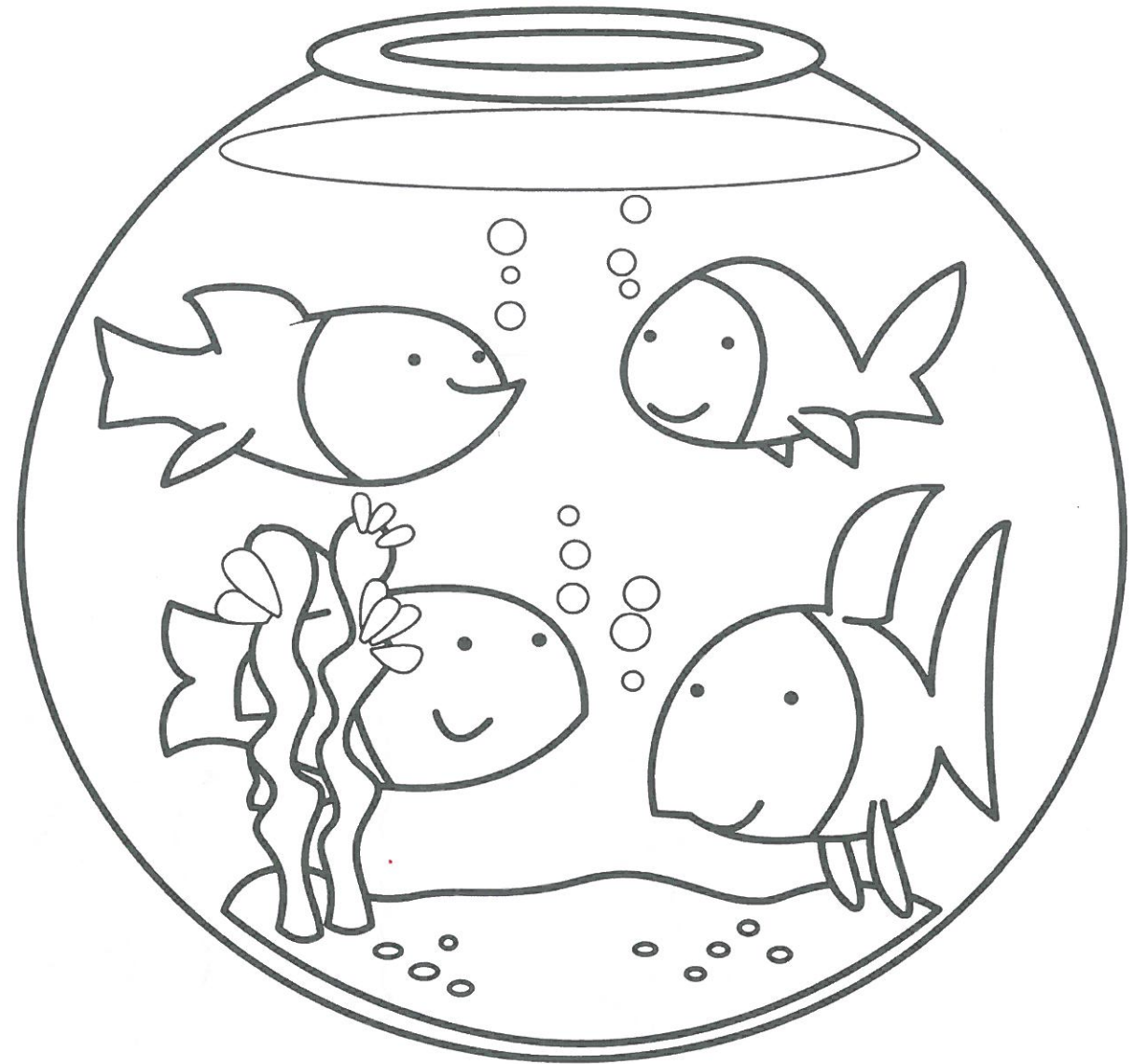
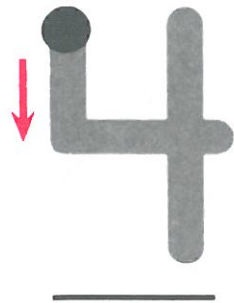

Color and paste cotton balls and black paper.

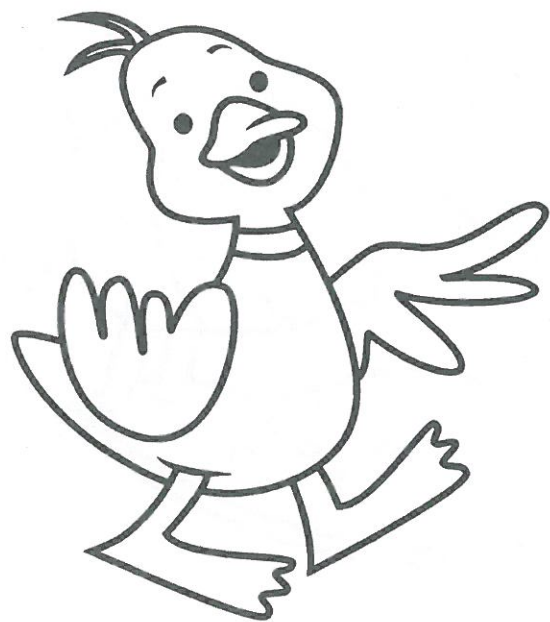
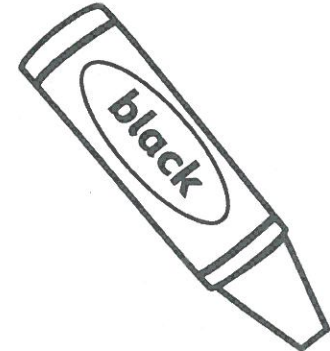
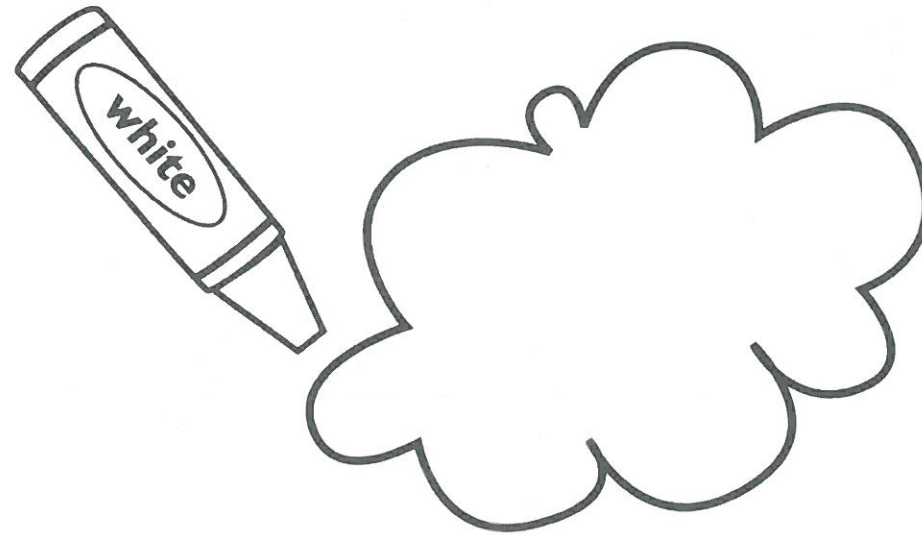



Look and listen. Trace.

Where's Lucy?



VALUES

Who is taking care of his pet? Color the frame.



Help the worm find the carrot. Color.

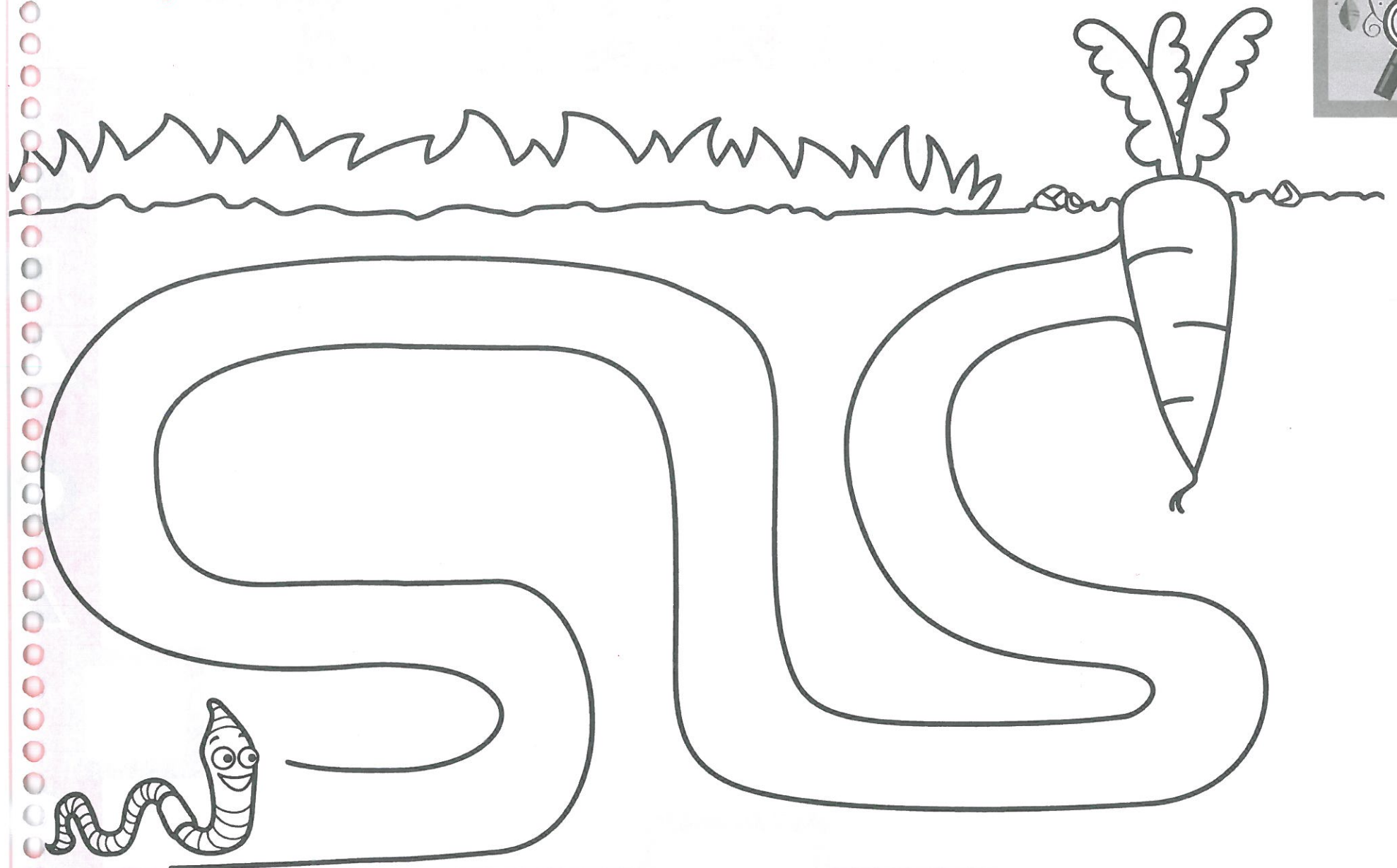

ANIMALS

Trace the shapes. Draw a pet.



8

MY WORLD

Find the doctor. Color.



Look and match.

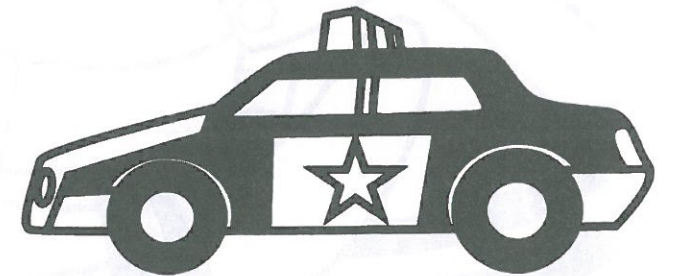
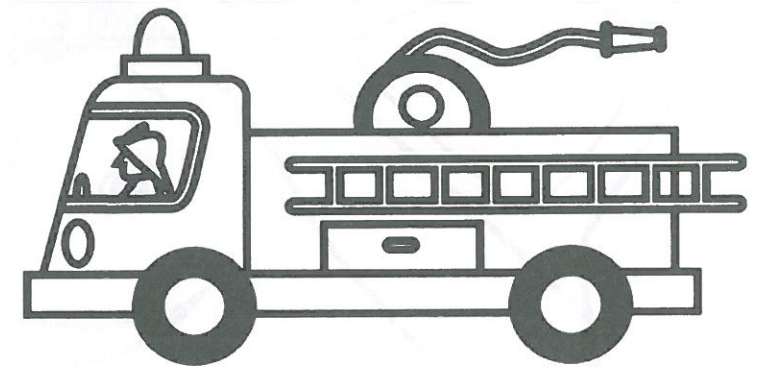
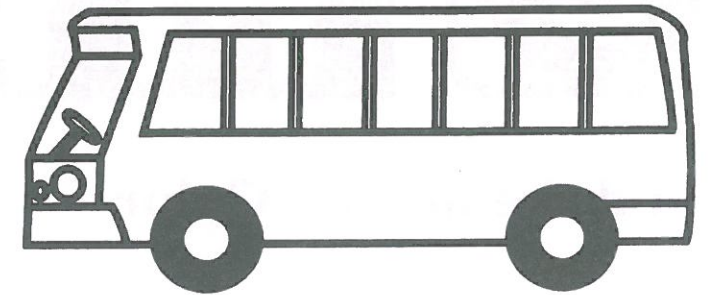

Look and circle the nurse and the dentist.

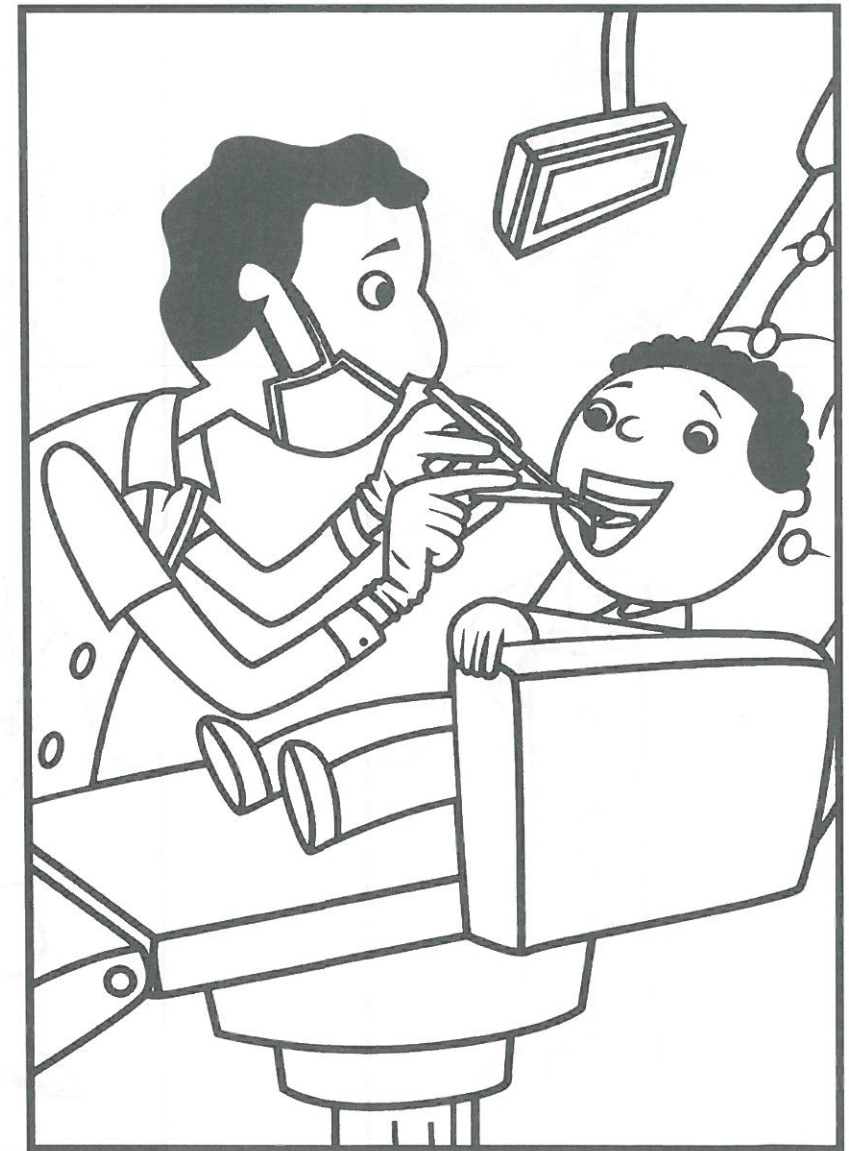
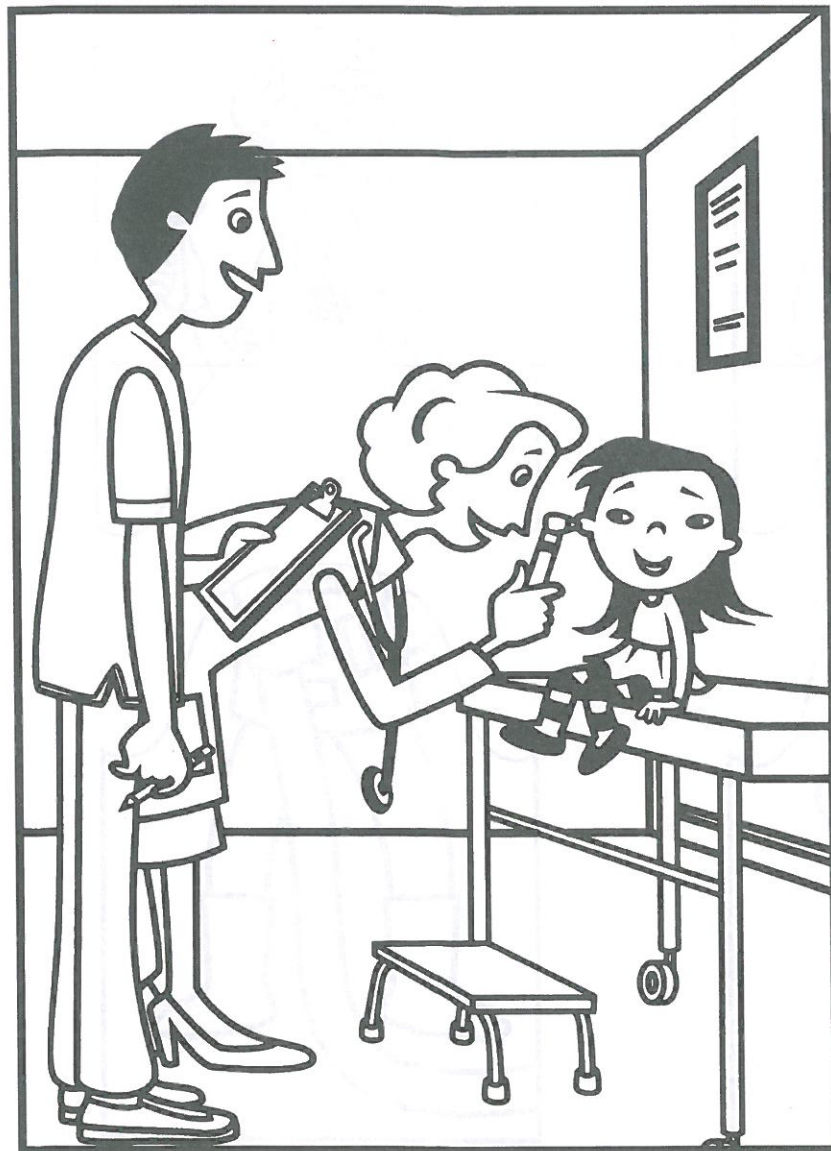

Vocabulary Practice: nurse, doctor, dentist

Look and match.

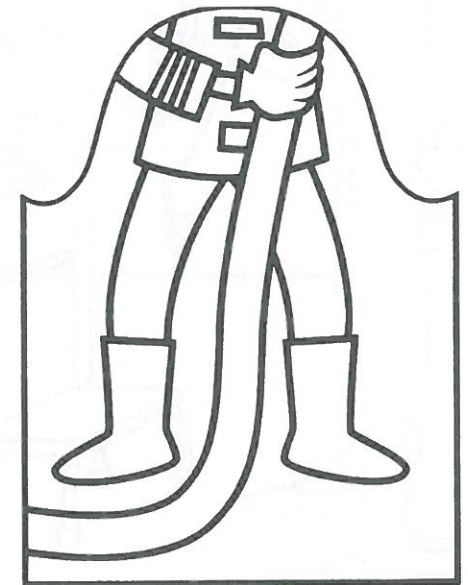
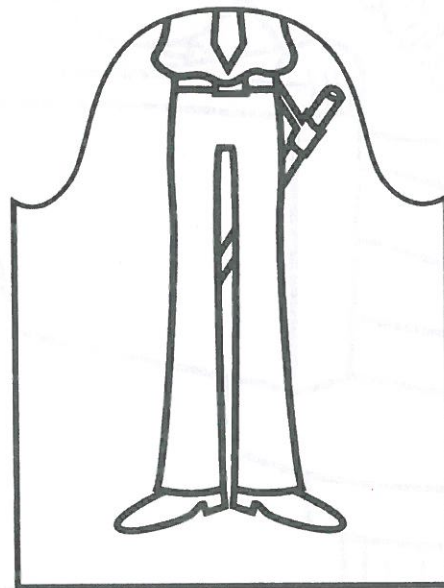
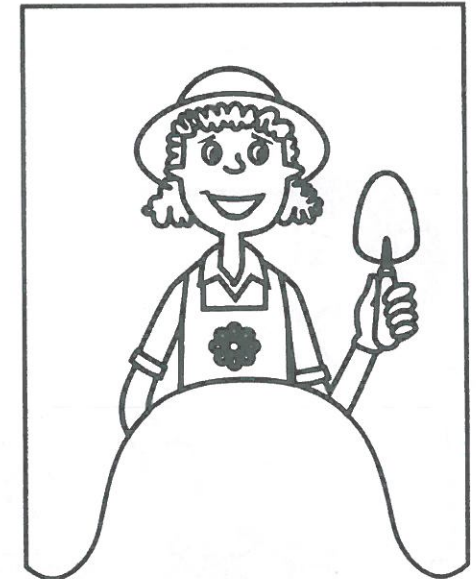

How many? Count the workers and circle. Trace and color the number.

5



Look and color.

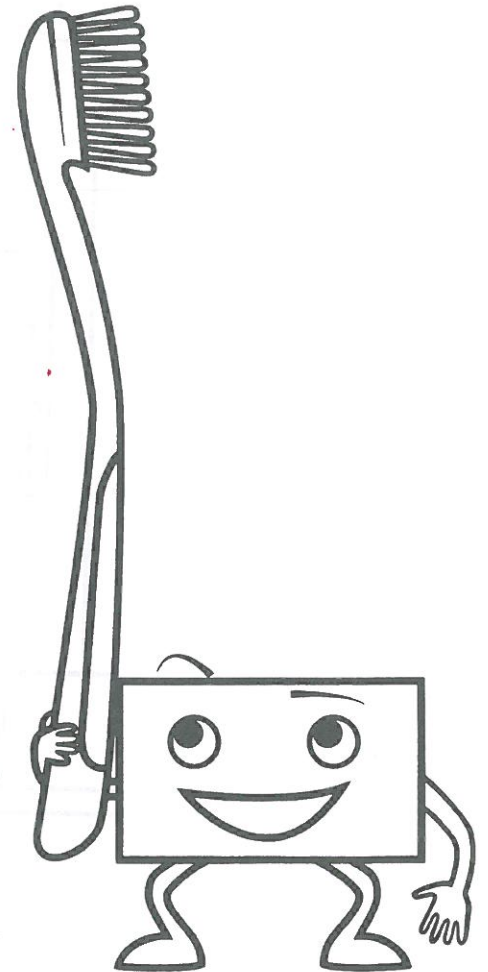
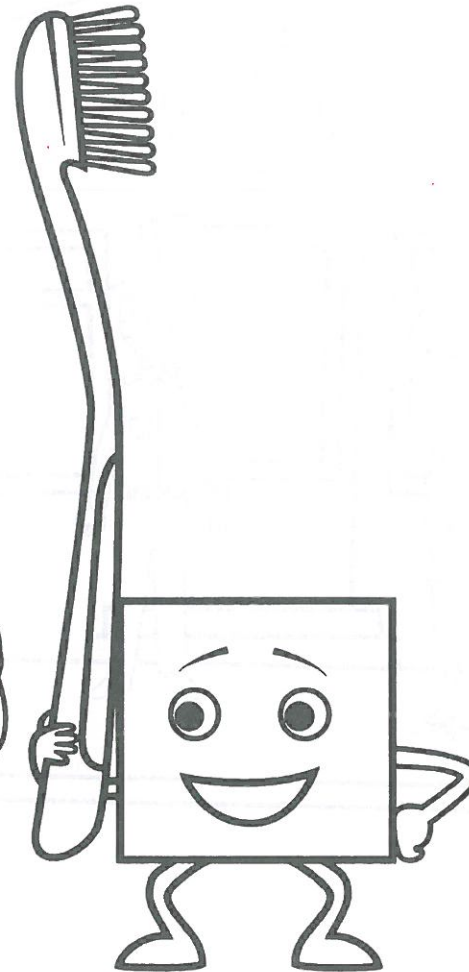
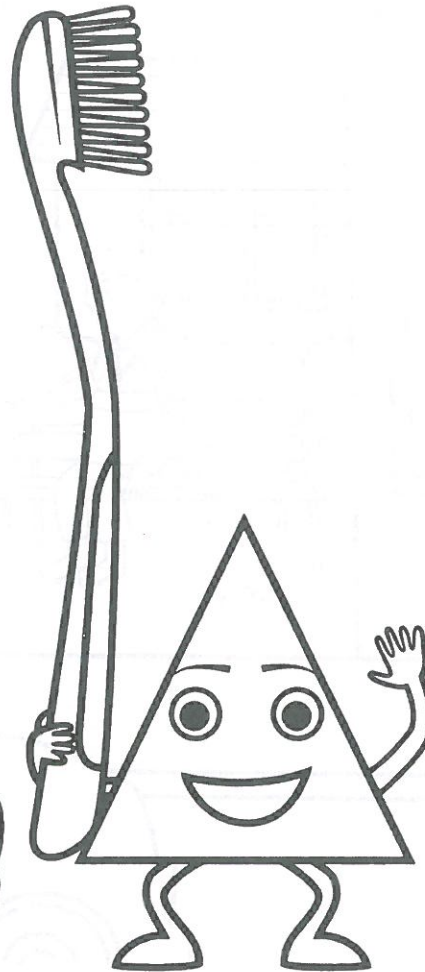
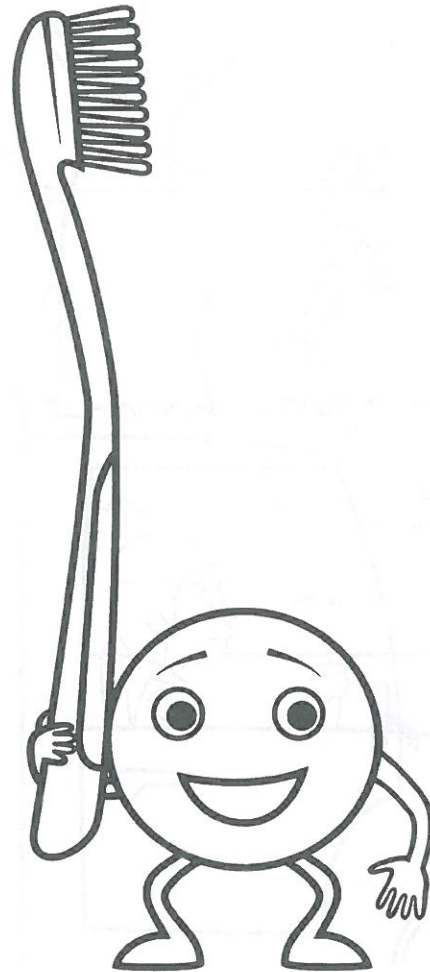
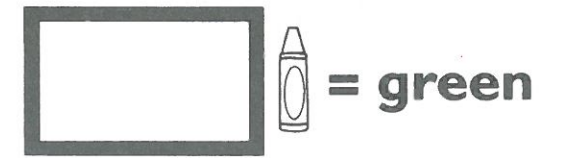
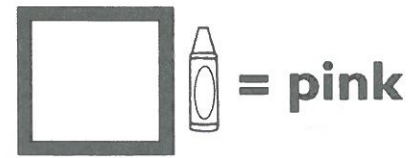
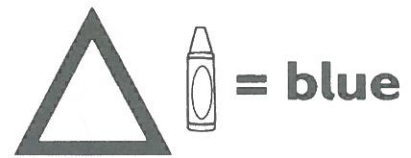
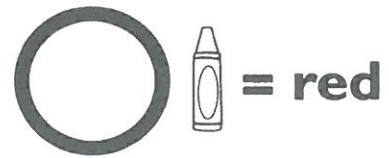



Look and listen. Trace.

Hospital

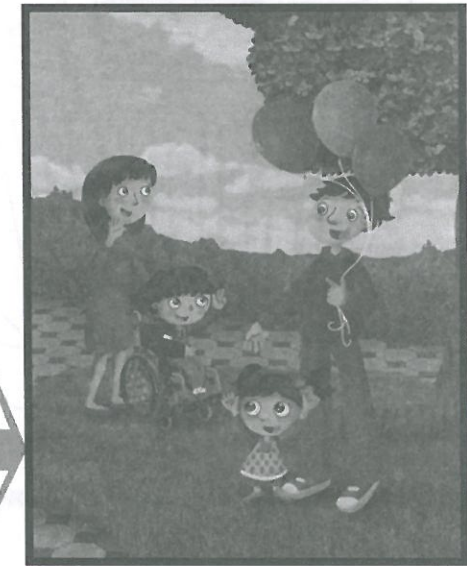
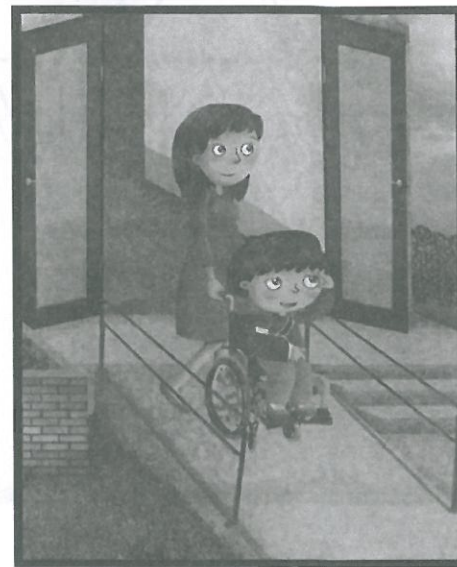

VALUES

Who is recycling? Color the frame.



Paste string on the hoses. Draw water. Color.

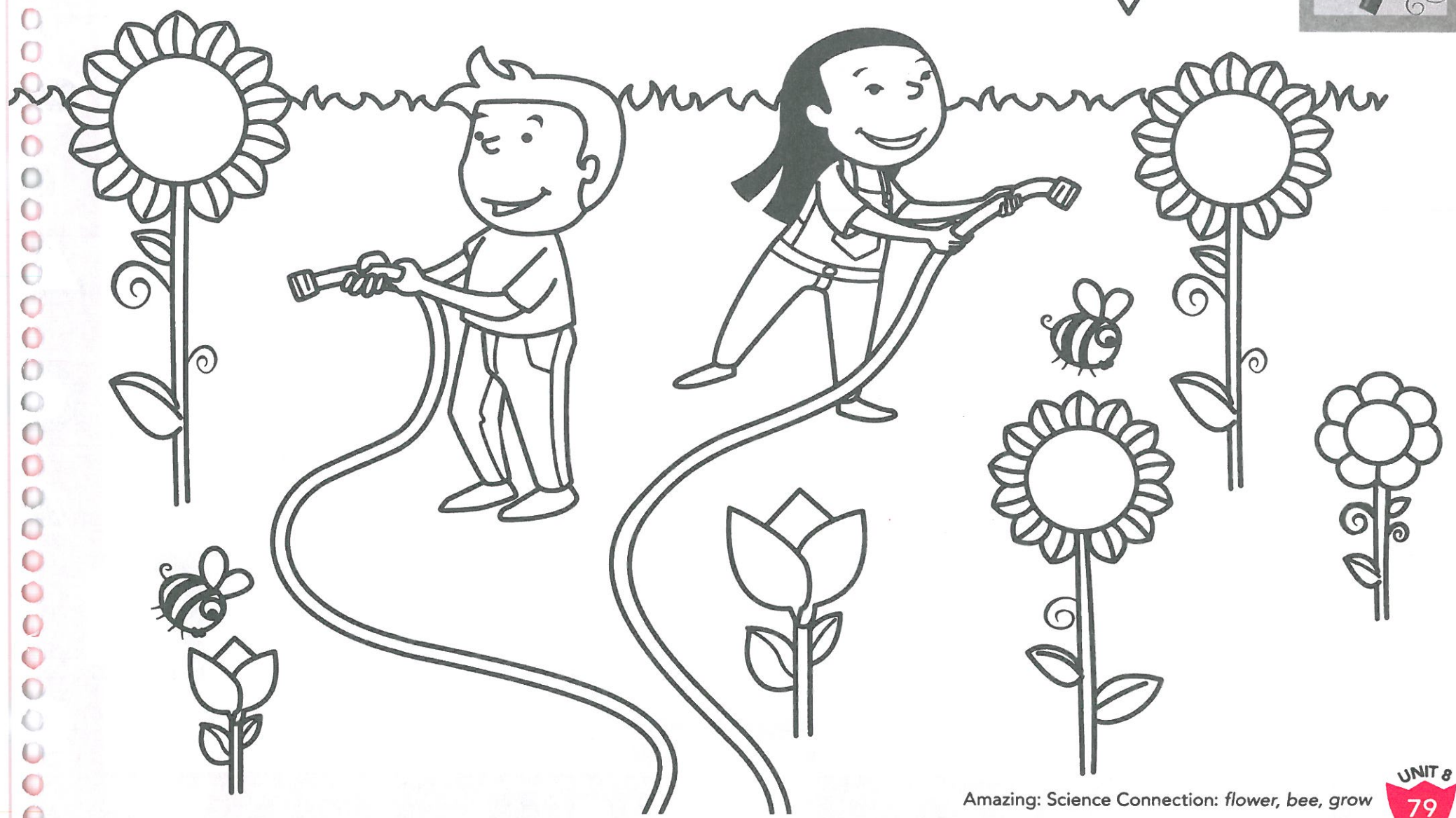
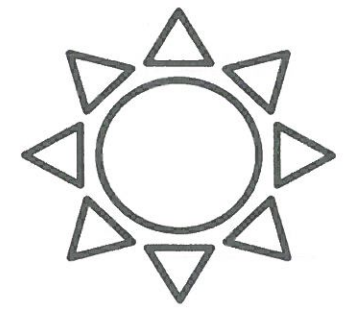



MY WORLD



Trace the shapes. Draw a firefighter or a nurse.

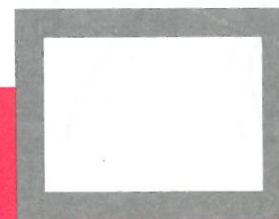

9

SHOW TIME!

Look and review.

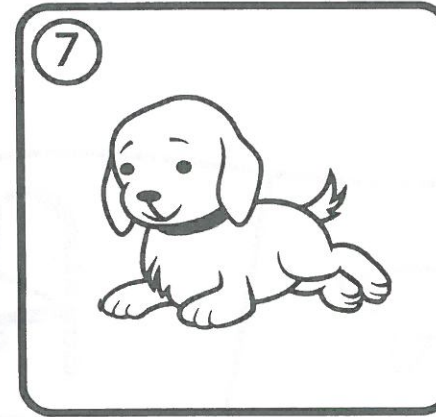
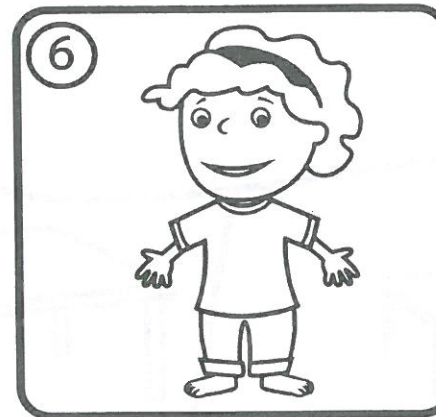
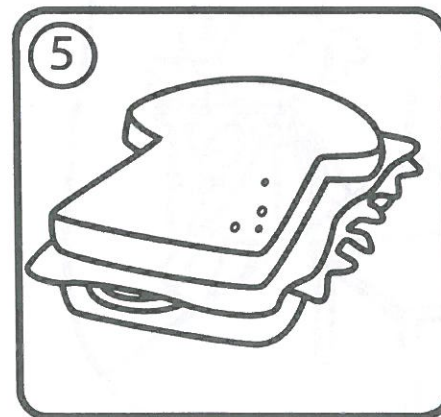
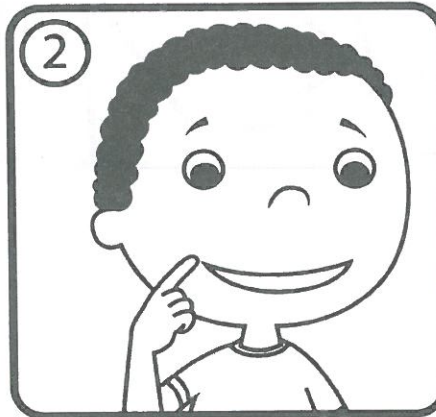
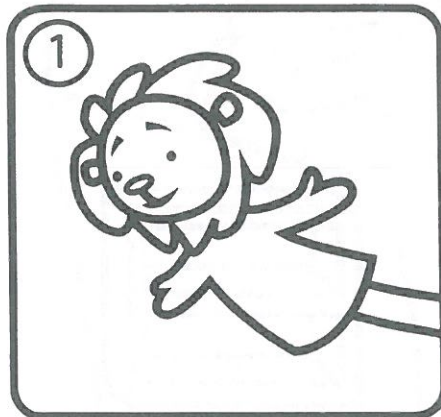

Review Units 1–8: puppet, mouth, grandparents, teddy bear, sandwich, T-shirt, pants, puppy, firefighter

Unit 1: Follow the path. Name the school objects.

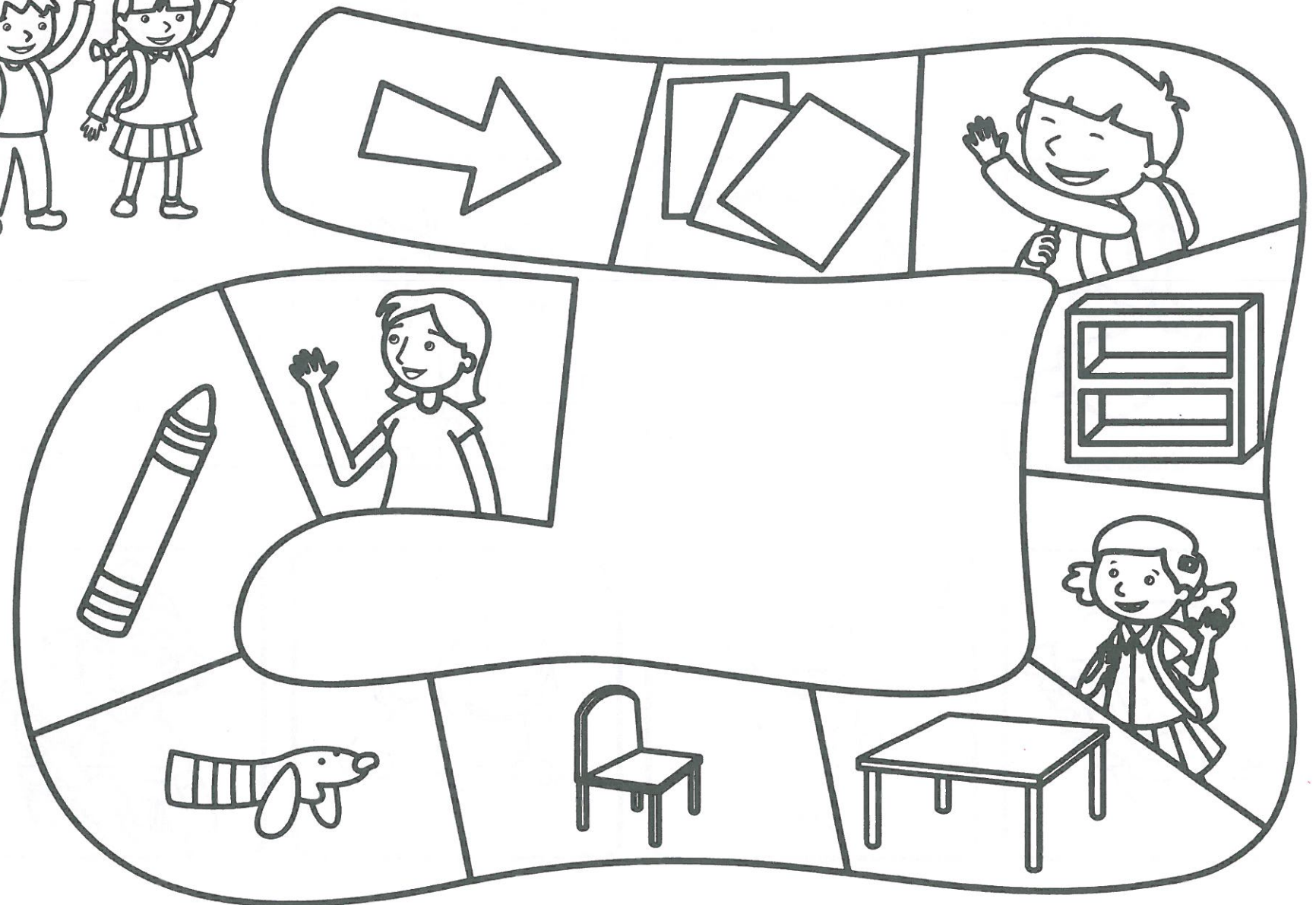

Unit 2: Draw the clown's eyes, nose, and mouth.



Unit 3: Name the family members and color the frames.

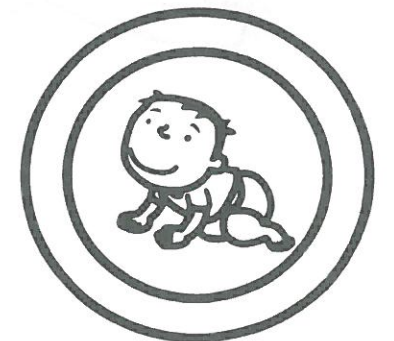
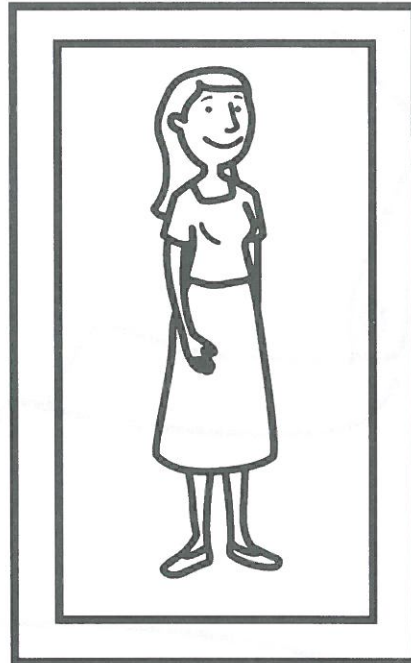
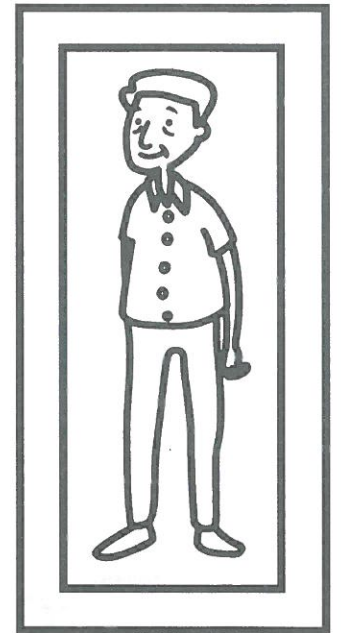
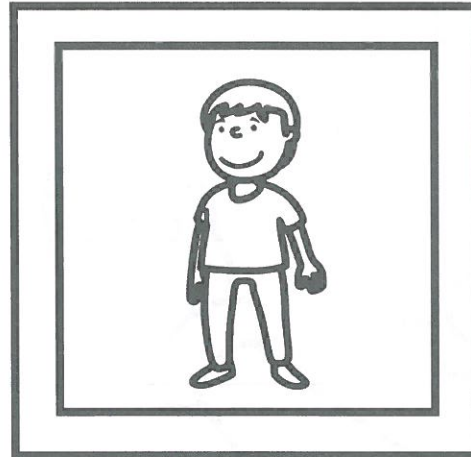
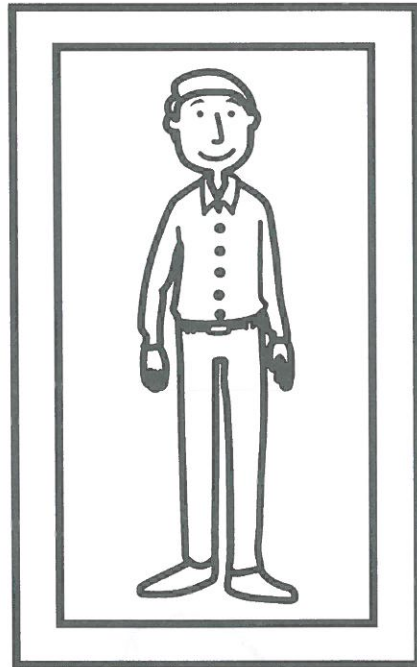

Unit 4: What do you want? Name and circle.

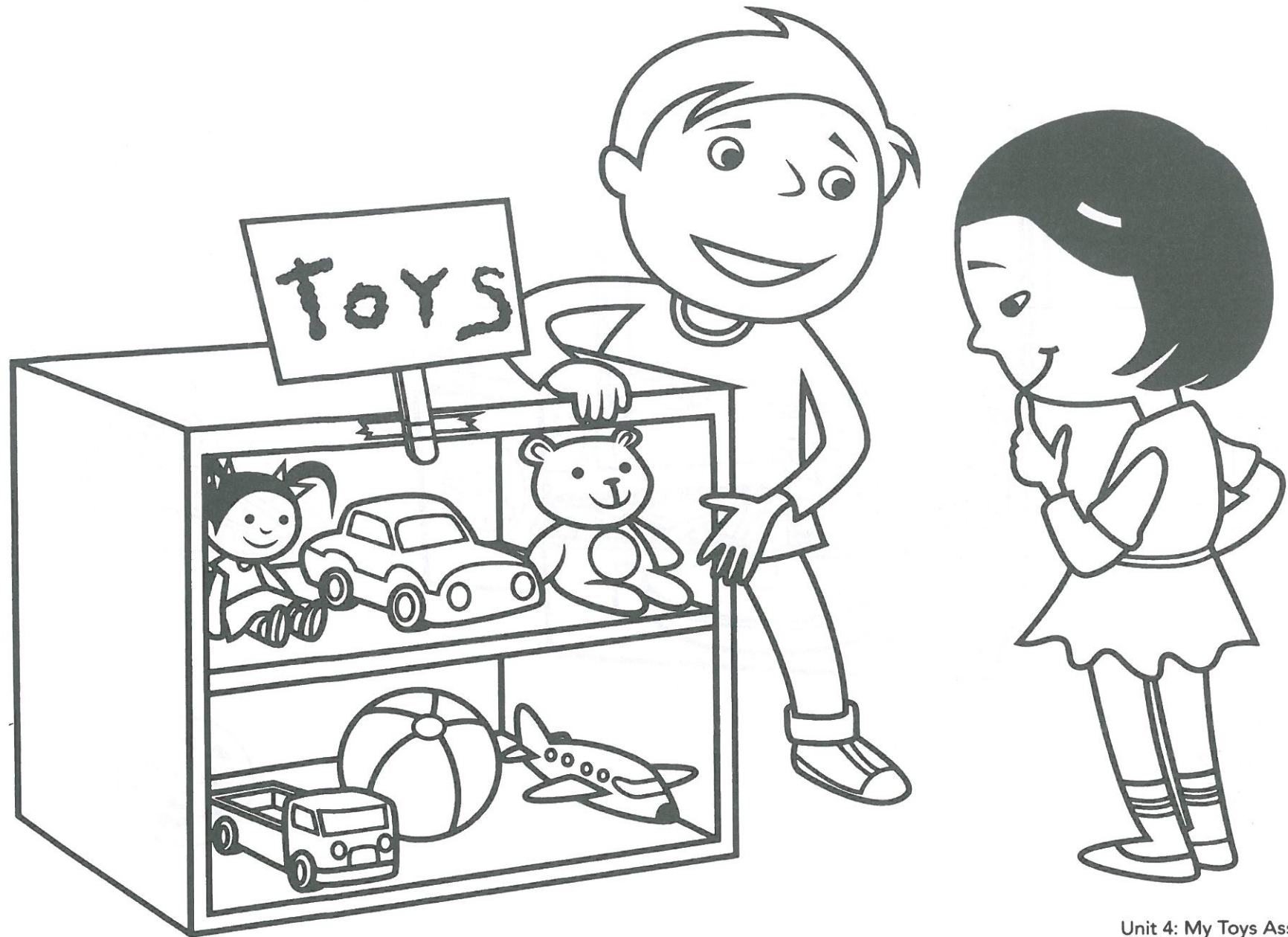

Unit 5: What is for lunch? Look and circle.

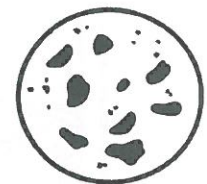
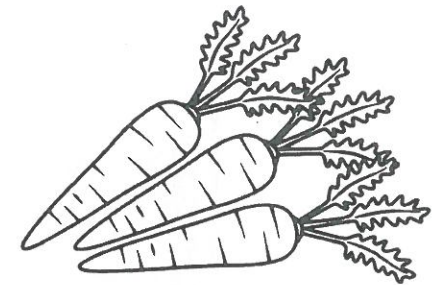
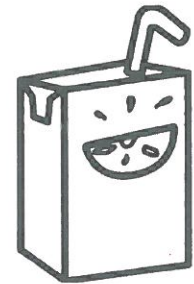
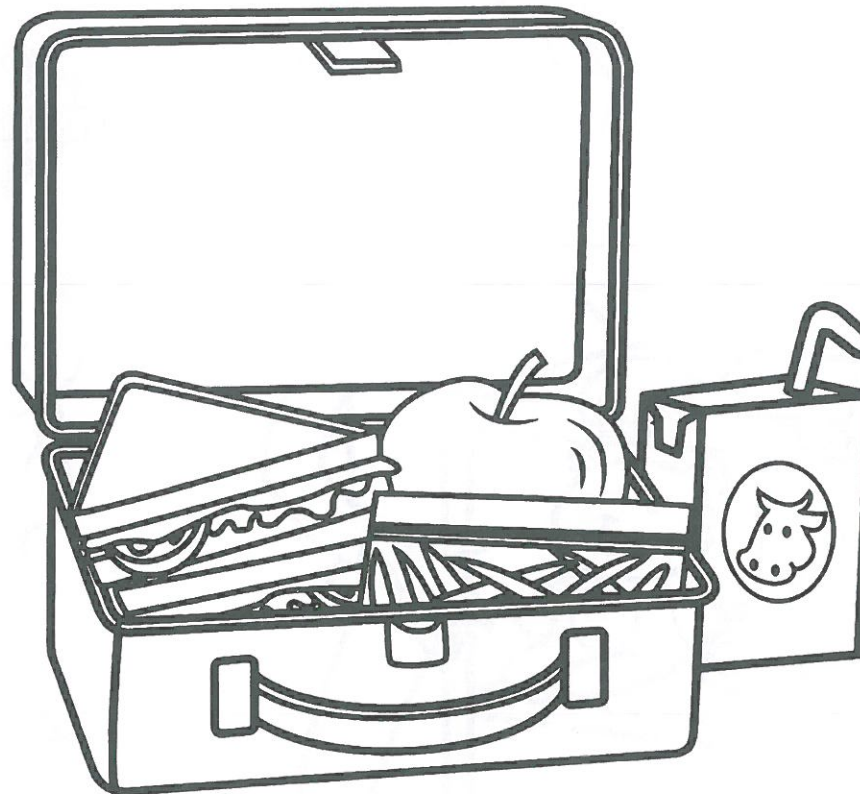
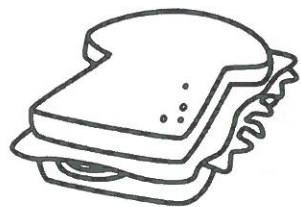
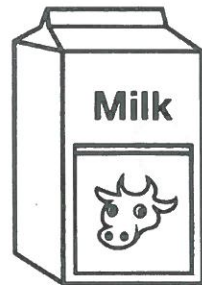
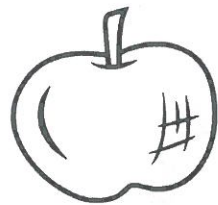

Unit 6: Match and color the girl's clothes.

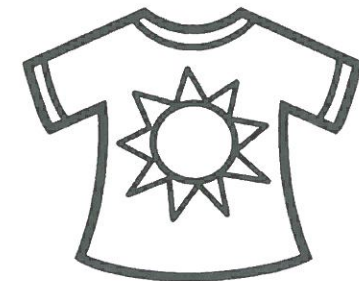
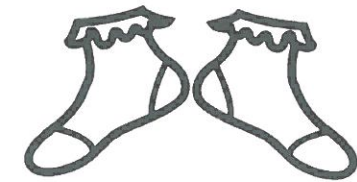
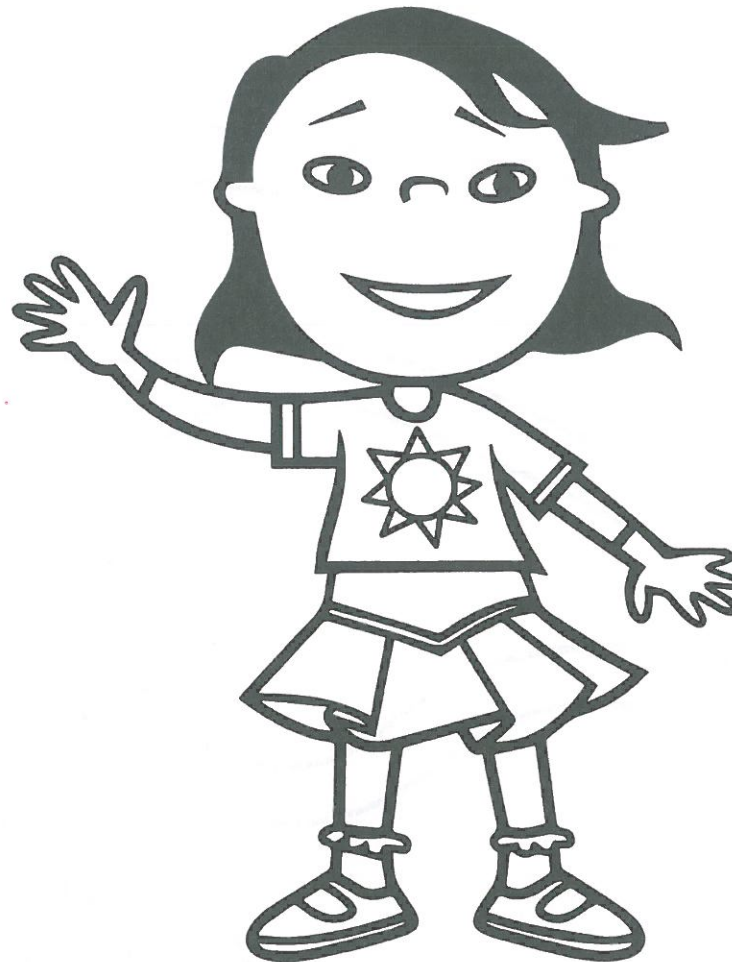
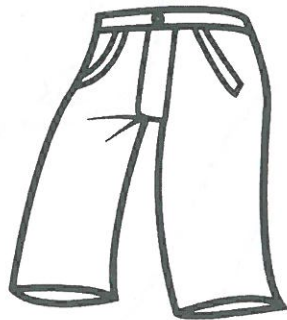
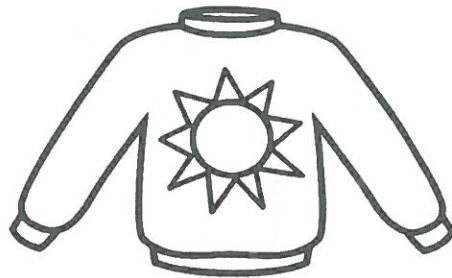
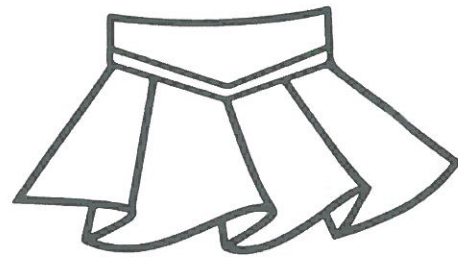

Unit 7: Trace the path and name the animals.

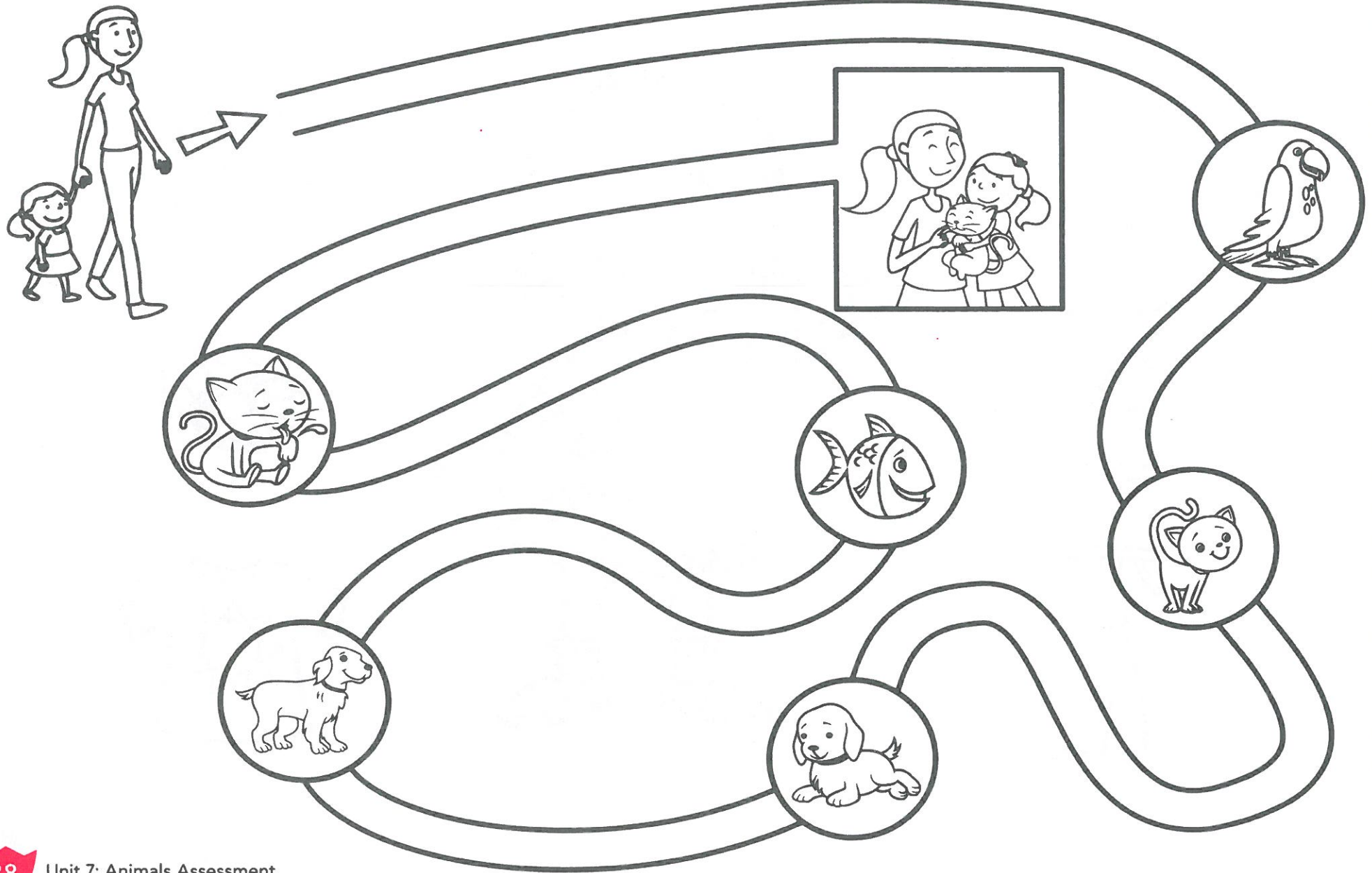

Unit 8: Name the community workers and match.

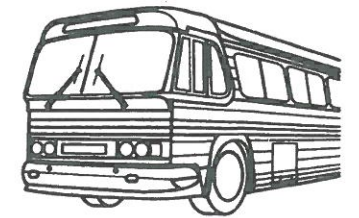
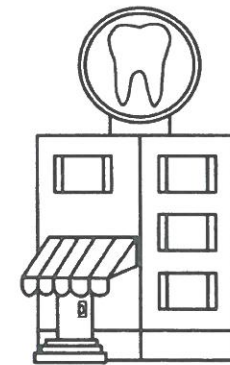
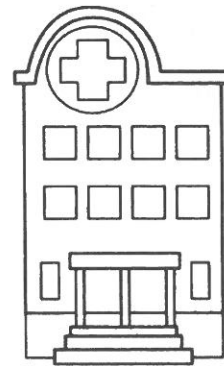
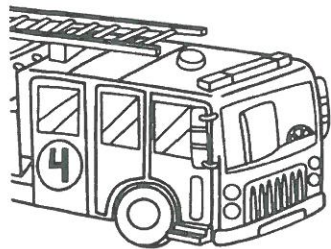
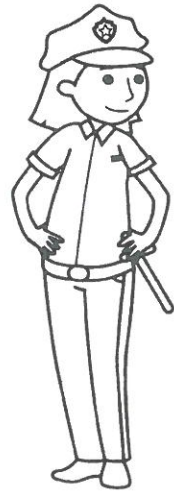

Workbook Audio CD

NEW BIG FUN WORKBOOK 1 Audio CD

TRACK	ACTIVITY
1	Copyright information
2	"Big Fun Theme Song"

Little Books

3	Unit 1 School Days
4	Unit 2 What Is This?
5	Unit 3 My Family
6	Unit 4 Dollhouse
7	Unit 5 A Surprise
8	Unit 6 Let's Play
9	Unit 7 Where's Lucy?
10	Unit 8 Hospital

Songs and Chants

Unit 1: My Class

11	"Hello Song"
12	"Hand Signal Chant"
13	"Let's Have Fun Song"
14	"Good-bye Song"
15	Target Song "My Class"
16	"Action Game Song"
17	"Shape Chant" (Circle)
18	"Let's Start Working"
19	"Color Song" (Red)
20	"Amazing Chant"
21	"My Garden"

Unit 2: My Body

22	"Sh! Sh! Sh!"
23	"Body Song"
24	Target Song "My Body"
25	"Actions Song"
26	"Shape Chant" (Square)
27	"Color Song" (Yellow)
28	"I Fly Like This"

Unit 3: My Family

29	"Around the Circle"
30	Target Song "My Family"
31	"Shape Chant" (Triangle)
32	"Color Song" (Blue)
33	"Families"
34	"We Love Bugs"

Unit 4: My Toys

35	Target Song "My Toys"
36	"Number Song: One!"
37	"Shape Chant" (Rectangle)
38	"Color Song" (Green)
39	"I Want Chant"
40	"Big and Small"
41	"Sharing Is Fun!"
42	"Fly Like a Bird"

Unit 5: My Lunch

43	Target Song "My Lunch"
44	"Number Song: Two!"
45	"Circles in the Air"
46	"Orange and Purple"
47	"Colors Review"
48	"The Wiggly Dance"

Unit 6: My Clothes

49	Target Song "My Clothes"
50	"Number Song: Three!"
51	"And Purple, Too!"
52	"Brown and Pink"
53	"Time for School Chant"
54	"Rain Song"

Unit 7: Animals

55	Target Song "Animals"
56	"Number Song: Four!"
57	"I Like Colors"
58	"Black and White"
59	"Up and Down Chant"
60	"Amazing Worms"

Unit 8: My World

61	Target Song "My World"
62	"Number Song: Five!"
63	"Fuzzy Caterpillar"
64	"Plants Grow"
65	"Watch Them Grow"

Unit 9: Show Time!

66	"Show Time"
----	-------------

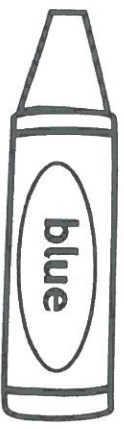

has finished New Big Fun Workbook 1!

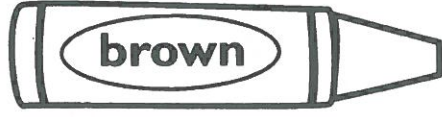
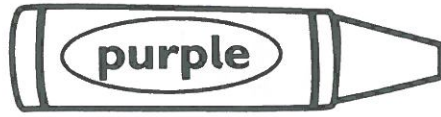
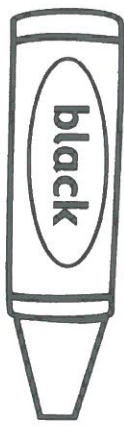
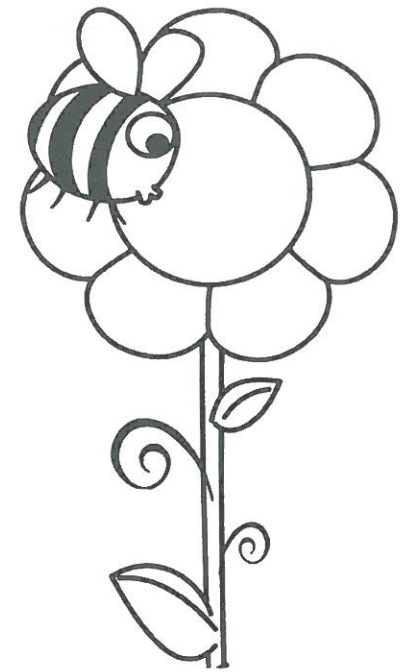

NEW BIG FUN WORKBOOK

1



**Share in your students' success.
Watch them enjoy learning
English and new skills.**

New Big Fun prepares students for a natural and positive experience with language:

- **Communication:** because young children like to express their interests and ideas
- **CLIL:** because young children are learning English and so much more
- **21st Century Skills:** because young children need to be prepared for the world that awaits them
- **Assessment for Learning:** because awareness and confidence lead to success.

Visit us at www.english.com/bigfun



ISBN 978-1-292-26573-5



9 781292 265735 >